



# IKHTISAR DATA PENDIDIKAN TAHUN 2016/2017



**KEMENTERIAN PENDIDIKAN DAN KEBUDAYAAN  
SEKRETARIAT JENDERAL  
PUSAT DATA DAN STATISTIK PENDIDIKAN DAN KEBUDAYAAN  
JAKARTA, 2017**



## **Kata Pengantar**

Buku Saku Ikhtisar Data Pendidikan ini disusun oleh Pusat Data dan Statistik Pendidikan dan Kebudayaan (PDSPK), Kementerian Pendidikan dan Kebudayaan (Kemendikbud), untuk memenuhi berbagai permintaan data dan informasi pendidikan, khususnya bagi pimpinan dan pengambil keputusan di lingkungan Kemendikbud.

Data pendidikan disajikan secara ringkas sekolah, siswa baru, siswa, kepala sekolah dan guru, rombongan belajar, ruang kelas, lulusan, putus sekolah dan mengulang, dilengkapi dengan indikator pendidikan, angka melanjutkan (AM), angka partisipasi kasar (APK), angka partisipasi murni (APM).

Selain itu, disajikan pula perkembangan data dan indikator pendidikan. Agar mudah dipahami, data disajikan dalam bentuk tabel dan grafik. Waktu pencatatan data untuk jenjang TK, SLB, SD, SMP, SMA, dan SMK adalah 31 Oktober 2016.

Semoga buku ini bermanfaat, kritik dan saran untuk penyempurnaan sangat kami harapkan.

Sekretaris Jenderal

Didik Suhardi, Ph.D

NIP.196312031983031004



## DAFTAR ISI

	<b>Hal</b>
Kata Pengantar	i
Daftar Isi	ii
 <b>Data Pendidikan</b>	
Tabel 1 : Data Pokok Pendidikan Menurut Jenjang Pendidikan Tahun 2016/2017	1
Grafik 1 : Jumlah Sekolah Berdasarkan Jenjang Pendidikan dan Status Tahun 2016/2017	1
Grafik 2 : Persentase Siswa menurut Jenis Kelamin dan Jenjang Pendidikan Tahun 2016/2017	2
Grafik 3 : Persentase Kepala Sekolah +Guru menurut Jenis Kelamin dan Jenjang Pendidikan Tahun 2016/2017	2
Tabel 2 : Data Pokok Pendidikan Taman Kanak-Kanak Tiap Provinsi Tahun 2016/2017	3
Tabel 3 : Data Pokok Pendidikan Sekolah Luar Biasa Tiap Provinsi Tahun 2016/2017	4
Tabel 4 : Data Pokok Pendidikan Sekolah Dasar Tiap Provinsi Tahun 2016/2017	5
Tabel 5 : Data Pokok Pendidikan Sekolah Menengah Pertama Tiap Provinsi Tahun 2016/2017	7
Tabel 6 : Data Pokok Pendidikan Sekolah Menengah Atas Tiap Provinsi Tahun 2016/2017	9
Tabel 7 : Data Pokok Pendidikan Sekolah Menengah Kejuruan Tiap Provinsi Tahun 2016/2017	11
Tabel 8 : Jumlah Siswa Menurut Jenis Kelamin dan Status Tiap Provinsi Tahun 2016/2017	13
Tabel 9 : Jumlah Siswa Menurut Tingkat, Jenjang Pendidikan dan Status Tahun 2016/2017	15
Grafik 4 : Jumlah Siswa menurut Tingkat dan Status sekolah Tahun 2016/2017	15
Tabel 10 : Jumlah Siswa Putus Sekolah Jenjang Sekolah Dasar Menurut Tingkat Tiap Provinsi Tahun 2016/2017	17
Tabel 11 : Jumlah Siswa Putus Sekolah Jenjang Sekolah Menengah Pertama Menurut Tingkat Tiap Provinsi Tahun 2016/2017	18



	<b>Hal</b>
Tabel 12 : Jumlah Siswa Putus Sekolah Jenjang Sekolah Menengah Atas Menurut Tingkat Tiap Provinsi Tahun 2016/2017	19
Tabel 13 : Jumlah Siswa Putus Sekolah Jenjang Sekolah Menengah Kejuruan Menurut Tingkat Tiap Provinsi Tahun 2016/2017	20
Grafik 5 : Grafik Siswa Putus Sekolah Menurut Jenis Kelamin Tahun 2016/2017	21
Grafik 6 : Grafik Mengulang Menurut Jenis Kelamin Tahun 2016/2017	21
Tabel 14 : Jumlah Siswa Mengulang Jenjang Sekolah Dasar Menurut Tingkat Tiap Provinsi Tahun 2016/2017	22
Tabel 15 : Jumlah Siswa Mengulang Jenjang Sekolah Menengah Pertama Menurut Tingkat Tiap Provinsi Tahun 2016/2017	23
Tabel 16 : Jumlah Siswa Mengulang Jenjang Sekolah Menengah Atas Menurut Tingkat Tiap Provinsi Tahun 2016/2017	24
Tabel 17 : Jumlah Siswa Mengulang Jenjang Sekolah Menengah Kejuruan Menurut Tingkat Tiap Provinsi Tahun 2016/2017	25
Grafik 7 : Perkembangan Jumlah Siswa Putus Sekolah Menurut Jenjang Pendidikan Tahun 2016/2017	26
Grafik 8 : Perkembangan Jumlah Siswa Mengulang Menurut Jenjang Pendidikan Tahun 2016/2017	26
Tabel 18 : Jumlah Kepala Sekolah + Guru Taman Kanak-kanak Menurut Ijazah Tertinggi Tiap Provinsi Tahun 2016/2017	27
Tabel 19 : Jumlah Kepala Sekolah + Guru Sekolah Luar Biasa Menurut Ijazah Tertinggi Tiap Provinsi Tahun 2016/2017	28
Tabel 20 : Jumlah Kepala Sekolah + Guru Sekolah Dasar Menurut Ijazah Tertinggi Tiap Provinsi Tahun 2016/2017	29
Tabel 21 : Jumlah Kepala Sekolah + Guru Sekolah Menengah Pertama Menurut Ijazah Tertinggi Tiap Provinsi Tahun 2016/2017	30



	<b>Hal</b>
Tabel 22 : Jumlah Kepala Sekolah + Guru Sekolah Menengah Atas Menurut Ijazah Tertinggi Tiap Provinsi Tahun 2016/2017	31
Tabel 23 : Jumlah Kepala Sekolah + Guru Sekolah Menengah Kejuruan Menurut Ijazah Tertinggi Tiap Provinsi Tahun 2016/2017	32
Grafik 9 : Persentase Kepala Sekolah + Guru Menurut Ijazah Tertinggi Semua Jenjang Pendidikan Tahun 2016/2017	33
Grafik 10 : Persentase Kepala Sekolah + Guru Menurut Jabatan Semua Jenjang Pendidikan Tahun 2016/2017	33
Tabel 24 : Jumlah Rombongan Belajar Sekolah Dasar Menurut Tingkat Tiap Provinsi Tahun 2016/2017	34
Tabel 25 : Jumlah Rombongan Belajar Sekolah Menengah Pertama Menurut Tingkat Tiap Provinsi Tahun 2016/2017	35
Tabel 26 : Jumlah Rombongan Belajar Sekolah Menengah Atas Menurut Tingkat Tiap Provinsi Tahun 2016/2017	36
Tabel 27 : Jumlah Rombongan Belajar Sekolah Menengah Kejuruan Menurut Tingkat Tiap Provinsi Tahun 2016/2017	37
Tabel 28 : Jumlah Ruang Kelas Menurut Kondisi dan Jenjang Pendidikan Semua Jenjang Pendidikan Tahun 2016/2017	38
Grafik 11 : Persentase Ruang Kelas Menurut Kondisi Semua Jenjang Pendidikan Tahun 2016/2017	38
Tabel 29 : Jumlah Ruang Kelas Sekolah Dasar Menurut Kondisi Tiap Provinsi Tahun 2016/2017	39
Tabel 30 : Jumlah Ruang Kelas Sekolah Luar Biasa Menurut Kondisi Tiap Provinsi Tahun 2016/2017	40
Tabel 31 : Jumlah Ruang Kelas Sekolah Menengah Pertama Menurut Kondisi Tiap Provinsi Tahun 2016/2017	41
Tabel 32 : Jumlah Ruang Kelas Sekolah Menengah Atas Menurut Kondisi Tiap Provinsi Tahun 2016/2017	42
Tabel 33 : Jumlah Ruang Kelas Sekolah Menengah Kejuruan Menurut Kondisi Tiap Provinsi Tahun 2016/2017	43
Tabel 34 : Angka Melanjutkan SD ke SMP Tiap Provinsi Tahun 2016/2017	44
Tabel 35 : Angka Melanjutkan SMP ke SM Tiap Provinsi Tahun 2016/2017	45



	<b>Hal</b>
Tabel 36 : Angka Partisipasi Kasar PAUD, SD, SMP, SM Sederajat Tahun 2016/2017	46
Grafik 12 : Angka Partisipasi Kasar PAUD, SD, SMP, SM Sederajat Tahun 2016/2017	46
Tabel 37 : Angka Partisipasi Murni PAUD, SD, SMP, SM Sederajat Tahun 2016/2017	47
Grafik 13 : Angka Partisipasi Murni PAUD, SD, SMP, SM Sederajat Tahun 2016/2017	47
Tabel 38 : Angka Partisipasi Kasar dan Angka Partisipasi Murni Tiap Provinsi SD, SMP, SM Sederajat Tahun 2016/2017	48



**Tabel : 1**  
**Data Pokok Pendidikan Menurut Jenjang Pendidikan**  
**Tahun 2016/2017**

No.	Jenjang Pendidikan	Sekolah	Siswa Baru	Siswa	KS + Guru	Rombongan Belajar	Ruang Kelas	Lulusan	Mengulang	Putus Sekolah
(1)	(2)	(3)	(4)	(5)	(6)	(7)	(8)	(9)	(10)	(11)
1.	<b>TK</b>	<b>88.381</b>	...	<b>4.605.809</b>	<b>329.102</b>	...	...	...		
	a. Negeri	3.207	...	316.848	18.596	...	...	...		
	b. Swasta	85.174	...	4.288.961	310.506	...	...	...		
2.	<b>SLB</b>	<b>2.070</b>	<b>27.991</b>	<b>121.244</b>	<b>24.657</b>	<b>29.928</b>	<b>19.727</b>	<b>3.956</b>	<b>4.178</b>	<b>133</b>
	a. Negeri	545	10.774	47.399	9.403	10.750	7.343	1.592	1.899	38
	b. Swasta	1.525	17.217	73.845	15.254	19.178	12.384	2.364	2.279	95
3.	<b>SD</b>	<b>147.503</b>	<b>4.172.791</b>	<b>25.618.078</b>	<b>1.586.127</b>	<b>1.103.232</b>	<b>1.049.116</b>	<b>4.400.553</b>	<b>361.215</b>	<b>39.213</b>
	a. Negeri	132.022	3.616.345	22.428.159	1.407.691	968.018	918.033	3.941.344	331.476	33.177
	b. Swasta	15.481	556.446	3.189.919	178.436	135.214	131.083	459.209	29.739	6.036
4.	<b>SMP</b>	<b>37.763</b>	<b>3.436.103</b>	<b>10.145.416</b>	<b>622.781</b>	<b>348.174</b>	<b>347.592</b>	<b>3.281.211</b>	<b>23.449</b>	<b>38.702</b>
	a. Negeri	22.803	2.587.795	7.585.324	466.189	255.409	254.366	2.469.472	15.809	25.714
	b. Swasta	14.960	848.308	2.560.092	156.592	92.765	93.226	811.649	7.640	12.988
5.	<b>SMA</b>	<b>13.144</b>	<b>1.646.765</b>	<b>4.659.542</b>	<b>294.872</b>	<b>155.162</b>	<b>151.441</b>	<b>1.263.211</b>	<b>7.340</b>	<b>36.419</b>
	a. Negeri	6.567	1.219.300	3.416.755	213.777	108.939	106.496	926.157	4.301	21.996
	b. Swasta	6.577	427.465	1.242.787	81.095	46.223	44.945	337.054	3.039	14.423
6.	<b>SMK</b>	<b>13.236</b>	<b>1.705.848</b>	<b>4.682.913</b>	<b>276.099</b>	<b>165.386</b>	<b>143.175</b>	<b>1.285.178</b>	<b>9.844</b>	<b>72.744</b>
	a. Negeri	3.434	746.973	2.004.055	134.332	68.951	59.870	532.895	5.263	26.059
	b. Swasta	9.802	958.875	2.678.858	141.767	96.435	83.305	752.283	4.581	46.685
<b>Jumlah Total</b>		<b>302.097</b>	<b>10.989.498</b>	<b>49.833.002</b>	<b>3.133.638</b>	<b>1.801.882</b>	<b>1.711.051</b>	<b>10.234.019</b>	<b>406.026</b>	<b>187.211</b>
a. Negeri		168.578	8.181.187	35.798.540	2.249.988	1.412.067	1.346.108	7.871.460	358.748	106.984
b. Swasta		133.519	2.808.311	14.034.462	883.650	389.815	364.943	2.362.559	47.278	80.227

Catatan : ... Data tidak tersedia

Blok Hitam tidak berlaku untuk jenjang tersebut

**Grafik : 1**  
**Jumlah Sekolah Berdasarkan Jenjang Pendidikan dan Status**  
**Tahun 2016/2017**

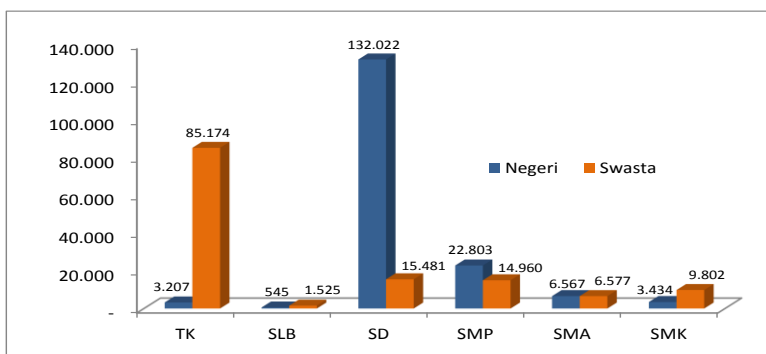

**Grafik : 2**  
Persentase Siswa menurut Jenis Kelamin dan Jenjang Pendidikan  
Tahun 2016/2017

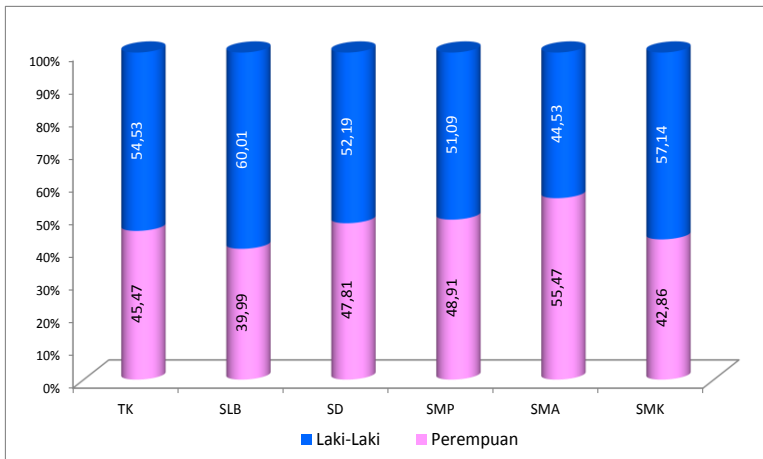

**Grafik : 3**  
Persentase KS+Guru menurut Jenis Kelamin dan Jenjang Pendidikan  
Tahun 2016/2017

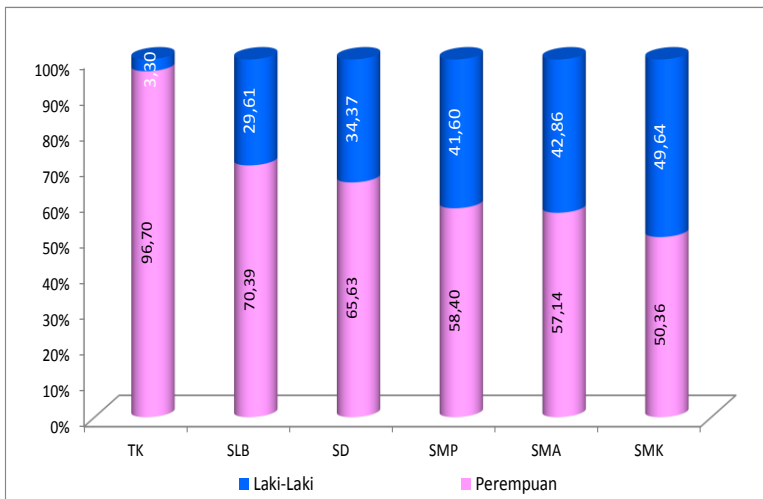





**Tabel : 2**  
**Data Pokok Pendidikan Taman Kanak-Kanak Tiap Provinsi**  
**Tahun 2016/2017**

No.	Provinsi	Sekolah	S i s w a	KS + Guru
(1)	(2)	(3)	(4)	(5)
1	DKI Jakarta	2.468	132.602	9.652
2	Jawa Barat	8.445	416.246	34.380
3	Banten	2.109	179.784	9.619
4	Jawa Tengah	14.013	712.116	47.588
5	DI Yogyakarta	2.138	98.538	9.243
6	Jawa Timur	18.154	947.638	68.806
7	Aceh	2.288	112.165	11.005
8	Sumatera Utara	2.429	199.660	8.955
9	Sumatera Barat	2.338	93.739	7.639
10	R i a u	2.149	107.764	8.641
11	Kep. Riau	621	47.517	2.924
12	J a m b i	1.220	45.138	4.373
13	Sumatera Selatan	1.828	80.711	7.957
14	Bangka Belitung	348	32.609	1.952
15	Bengkulu	968	39.003	3.611
16	Lampung	2.827	124.457	11.319
17	Kalimantan Barat	733	59.465	3.210
18	Kalimantan Tengah	1.670	65.705	5.523
19	Kalimantan Selatan	2.404	104.999	10.204
20	Kalimantan Timur	1.315	55.703	5.717
21	Kalimantan Utara	163	13.729	880
22	Sulawesi Utara	1.593	71.383	2.718
23	Gorontalo	764	30.867	2.064
24	Sulawesi Tengah	1.964	88.479	6.268
25	Sulawesi Selatan	4.020	224.106	14.085
26	Sulawesi Barat	762	22.602	2.221
27	Sulawesi Tenggara	1.782	101.761	5.552
28	M a l u k u	610	22.973	1.248
29	Maluku Utara	539	24.105	1.334
30	B a l i	1.568	87.370	6.081
31	Nusa Tenggara Barat	1.698	118.456	7.700
32	Nusa Tenggara Timur	1.510	87.670	3.862
33	Papua	591	42.519	2.015
34	Papua Barat	352	14.230	756
<b>Indonesia</b>		<b>88.381</b>	<b>4.605.809</b>	<b>329.102</b>



**Tabel : 3**  
**Data Pokok Pendidikan Sekolah Luar Biasa Tiap Provinsi**  
**Tahun 2016/2017**

No.	Provinsi	Sekolah	Siswa Baru	S i s w a	Lulusan	KS + Guru	Rombongan Belajar	Ruang Kelas
(1)	(2)	(3)	(4)	(5)	(6)	(7)	(8)	(9)
1	DKI Jakarta	87	1.313	5.610	221	1.137	1.196	1.264
2	Jawa Barat	367	4.694	21.042	134	4.293	6.312	2.990
3	Banten	87	1.051	4.765	96	1.006	1.485	712
4	Jawa Tengah	174	3.580	15.488	478	2.842	3.044	2.585
5	DI Yogyakarta	76	1.085	4.893	33	1.288	1.418	1.194
6	Jawa Timur	437	4.339	17.416	1.261	3.601	4.334	2.878
7	Aceh	59	639	2.737	231	684	677	423
8	Sumatera Utara	48	1.223	4.212	136	631	696	507
9	Sumatera Barat	135	1.338	6.163	173	1.284	1.516	1.007
10	R i a u	41	576	2.654	22	475	573	386
11	Kep. Riau	13	248	1.110	48	188	220	155
12	J a m b i	16	330	1.494	51	304	335	215
13	Sumatera Selatan	30	634	2.271	24	448	464	345
14	Bangka Belitung	9	202	856	3	146	226	137
15	Bengkulu	15	297	1.221	15	236	273	196
16	Lampung	22	364	1.620	77	354	365	302
17	Kalimantan Barat	19	245	1.166	29	199	243	186
18	Kalimantan Tengah	22	228	1.003	55	224	284	173
19	Kalimantan Selatan	39	486	2.117	166	537	544	461
20	Kalimantan Timur	29	464	1.988	6	346	437	324
21	Kalimantan Utara	4	84	341	7	45	72	43
22	Sulawesi Utara	23	302	1.111	7	229	273	242
23	Gorontalo	8	153	893	18	201	285	106
24	Sulawesi Tengah	22	312	1.276	22	235	339	220
25	Sulawesi Selatan	79	1.018	4.720	96	1.118	1.311	851
26	Sulawesi Barat	22	189	1.051	8	215	270	114
27	Sulawesi Tenggara	55	444	2.482	189	486	597	288
28	M a l u k u	13	176	840	-	145	172	67
29	Maluku Utara	16	165	856	60	225	191	183
30	B a l i	16	414	1.828	8	360	390	234
31	Nusa Tenggara Barat	36	666	2.834	45	566	685	443
32	Nusa Tenggara Timur	34	594	2.429	188	487	517	373
33	Papua	12	100	578	25	98	132	104
34	Papua Barat	5	38	179	24	24	52	19
<b>Indonesia</b>		<b>2.070</b>	<b>27.991</b>	<b>121.244</b>	<b>3.956</b>	<b>24.657</b>	<b>29.928</b>	<b>19.727</b>



**Tabel : 4**  
**Data Pokok Pendidikan Sekolah Dasar Tiap Provinsi**  
**Tahun 2016/2017**

No.	Provinsi	Sekolah	Siswa Baru	S i s w a	Lulusan	KS + Guru
(1)	(2)	(3)	(4)	(5)	(6)	(7)
1	DKI Jakarta	2.522	129.661	815.318	139.116	35.977
2	Jawa Barat	19.793	745.164	4.516.574	799.818	213.794
3	Banten	4.535	198.450	1.198.472	204.852	56.396
4	Jawa Tengah	19.040	467.273	2.878.870	510.899	182.934
5	DI Yogyakarta	1.842	48.020	292.590	50.178	20.005
6	Jawa Timur	19.315	465.345	2.864.696	525.608	205.931
7	Aceh	3.422	80.712	483.896	79.779	47.761
8	Sumatera Utara	9.557	283.502	1.757.716	297.318	105.729
9	Sumatera Barat	4.139	104.186	648.211	107.866	44.121
10	R i a u	3.605	133.975	799.928	130.025	49.710
11	Kep. Riau	904	37.849	224.643	34.858	12.436
12	J a m b i	2.442	63.749	390.863	66.408	27.133
13	Sumatera Selatan	4.646	157.347	937.515	153.559	58.366
14	Bangka Belitung	802	26.812	158.669	25.918	8.530
15	Bengkulu	1.364	35.239	218.662	36.814	14.858
16	Lampung	4.641	143.227	846.401	141.077	54.904
17	Kalimantan Barat	4.349	98.176	601.076	99.019	38.554
18	Kalimantan Tengah	2.606	47.830	289.686	47.682	24.200
19	Kalimantan Selatan	2.901	64.142	381.950	64.976	29.915
20	Kalimantan Timur	1.838	70.150	413.209	66.768	24.447
21	Kalimantan Utara	460	13.786	79.089	12.368	5.545
22	Sulawesi Utara	2.219	36.803	250.976	46.198	18.214
23	Gorontalo	931	18.781	128.947	22.524	8.343
24	Sulawesi Tengah	2.869	53.139	355.151	62.152	26.771
25	Sulawesi Selatan	6.384	148.797	948.609	169.779	69.997
26	Sulawesi Barat	1.311	25.238	164.992	28.971	12.971
27	Sulawesi Tenggara	2.298	49.872	330.949	56.452	23.524
28	M a l u k u	1.725	35.738	228.846	37.475	16.775
29	Maluku Utara	1.245	23.100	155.628	25.577	9.840
30	B a l i	2.442	66.636	402.553	72.781	25.609
31	Nusa Tenggara Barat	3.156	86.541	512.297	88.445	39.353
32	Nusa Tenggara Timur	4.998	122.876	799.332	128.286	51.544
33	Papua	2.236	69.571	408.762	48.828	15.108
34	Papua Barat	966	21.104	133.002	18.179	6.832
	<b>Indonesia</b>	<b>147.503</b>	<b>4.172.791</b>	<b>25.618.078</b>	<b>4.400.553</b>	<b>1.586.127</b>



**Tabel : 4 lanjutan**  
**Data Pokok Pendidikan Sekolah Dasar Tiap Provinsi**  
**Tahun 2016/2017**

No.	Provinsi	Mengulang		Putus Sekolah		Rombongan Belajar	Ruang Kelas
		Jumlah	%	Jumlah	%		
(1)	(2)	(3)	(4)	(5)	(6)	(7)	(8)
1	DKI Jakarta	4.355	0,53	982	0,12	28.527	25.577
2	Jawa Barat	19.284	0,42	4.697	0,10	159.873	138.252
3	Banten	10.406	0,86	1.669	0,14	41.341	35.834
4	Jawa Tengah	53.167	1,83	2.205	0,08	127.426	127.670
5	DI Yogyakarta	3.080	1,06	170	0,06	13.537	13.893
6	Jawa Timur	27.294	0,94	1.808	0,06	134.636	133.879
7	Aceh	5.008	1,04	1.021	0,21	23.994	24.146
8	Sumatera Utara	17.080	0,96	4.075	0,23	72.942	70.234
9	Sumatera Barat	20.709	3,16	857	0,13	30.197	29.931
10	R i a u	12.749	1,59	1.401	0,17	33.392	30.460
11	Kep. Riau	2.621	1,18	278	0,13	9.054	7.651
12	J a m b i	5.801	1,47	771	0,19	18.491	17.595
13	Sumatera Selatan	15.140	1,60	1.948	0,21	39.059	34.217
14	Bangka Belitung	4.542	2,85	260	0,16	6.404	6.643
15	Bengkulu	4.225	1,91	451	0,20	10.489	10.292
16	Lampung	11.297	1,34	1.350	0,16	36.747	34.222
17	Kalimantan Barat	24.445	4,01	1.476	0,24	30.535	28.351
18	Kalimantan Tengah	5.854	1,99	675	0,23	17.194	16.860
19	Kalimantan Selatan	9.379	2,43	530	0,14	20.418	20.455
20	Kalimantan Timur	6.211	1,50	438	0,11	17.183	15.478
21	Kalimantan Utara	1.432	1,83	146	0,19	3.825	3.471
22	Sulawesi Utara	2.107	0,81	277	0,11	14.323	14.516
23	Gorontalo	4.504	3,35	290	0,22	6.197	6.410
24	Sulawesi Tengah	6.776	1,86	814	0,22	18.781	18.841
25	Sulawesi Selatan	11.697	1,21	2.550	0,26	45.458	43.965
26	Sulawesi Barat	2.554	1,51	451	0,27	8.866	8.590
27	Sulawesi Tenggara	6.035	1,79	1.000	0,30	16.310	15.621
28	M a l u k u	4.273	1,85	381	0,17	11.549	11.285
29	Maluku Utara	2.729	1,69	522	0,32	7.900	7.701
30	B a l i	2.193	0,54	188	0,05	17.011	16.669
31	Nusa Tenggara Barat	6.361	1,24	702	0,14	22.062	20.970
32	Nusa Tenggara Timur	31.328	3,84	1.980	0,24	36.939	38.236
33	Papua	12.170	3,03	2.356	0,59	15.867	15.071
34	Papua Barat	4.409	3,37	494	0,38	6.705	6.130
	<b>Indonesia</b>	<b>361.215</b>	<b>1,40</b>	<b>39.213</b>	<b>0,15</b>	<b>1.103.232</b>	<b>1.049.116</b>



**Tabel : 5**  
**Data Pokok Pendidikan Sekolah Menengah Pertama Tiap Provinsi**  
**Tahun 2016/2017**

No.	Provinsi	Sekolah	Siswa Baru	S i s w a	Lulusan	KS + Guru
(1)	(2)	(3)	(4)	(5)	(6)	(7)
1	DKI Jakarta	1.091	121.723	369.313	125.225	17.490
2	Jawa Barat	4.878	607.099	1.801.954	585.506	81.603
3	Banten	1.363	143.924	429.092	137.437	19.854
4	Jawa Tengah	3.243	408.918	1.209.241	410.712	70.865
5	DI Yogyakarta	432	43.083	129.305	44.154	8.825
6	Jawa Timur	4.480	427.311	1.267.489	422.254	79.367
7	Aceh	1.074	63.877	195.454	66.182	21.520
8	Sumatera Utara	2.451	227.480	665.139	210.676	39.965
9	Sumatera Barat	777	74.835	216.200	68.953	17.330
10	R i a u	1.105	90.056	260.187	80.164	17.888
11	Kep. Riau	331	29.736	83.518	24.587	4.619
12	J a m b i	643	42.782	126.563	40.649	9.953
13	Sumatera Selatan	1.277	122.428	355.251	110.855	23.094
14	Bangka Belitung	205	20.822	59.380	17.971	2.970
15	Bengkulu	415	30.951	88.808	28.448	6.618
16	Lampung	1.314	108.704	318.457	105.271	20.755
17	Kalimantan Barat	1.250	82.455	236.189	69.917	13.669
18	Kalimantan Tengah	796	37.155	108.204	32.801	8.371
19	Kalimantan Selatan	588	41.548	121.265	39.285	9.020
20	Kalimantan Timur	606	53.444	155.671	48.844	9.497
21	Kalimantan Utara	161	10.712	30.889	9.308	2.172
22	Sulawesi Utara	704	40.344	121.863	37.894	8.475
23	Gorontalo	324	17.647	50.644	15.722	3.819
24	Sulawesi Tengah	812	44.961	131.342	41.346	9.614
25	Sulawesi Selatan	1.617	129.532	390.852	128.281	27.840
26	Sulawesi Barat	338	20.980	63.243	19.066	4.387
27	Sulawesi Tenggara	730	43.399	128.703	40.012	10.088
28	M a l u k u	599	31.768	96.510	31.213	7.648
29	Maluku Utara	443	19.360	59.251	18.434	4.684
30	B a l i	402	65.274	196.845	66.021	11.513
31	Nusa Tenggara Barat	857	60.316	181.961	58.190	16.790
32	Nusa Tenggara Timur	1.581	116.482	329.792	98.487	22.530
33	Papua	596	40.690	120.260	33.792	6.764
34	Papua Barat	280	16.307	46.581	13.464	3.184
<b>Indonesia</b>		<b>37.763</b>	<b>3.436.103</b>	<b>10.145.416</b>	<b>3.281.121</b>	<b>622.781</b>



**Tabel : 5 lanjutan**  
**Data Pokok Pendidikan Sekolah Menengah Pertama Tiap Provinsi**  
**Tahun 2016/2017**

No.	Provinsi	Mengulang		Putus Sekolah		Rombongan Belajar	Ruang Kelas
		Jumlah	%	Jumlah	%		
(1)	(2)	(3)	(4)	(5)	(6)	(7)	(8)
1	DKI Jakarta	1.354	0,37	1.080	0,29	12.010	11.692
2	Jawa Barat	2.104	0,12	8.635	0,48	54.740	52.289
3	Banten	715	0,17	1.727	0,40	13.264	13.405
4	Jawa Tengah	2.288	0,19	3.673	0,30	40.453	40.969
5	DI Yogyakarta	232	0,18	239	0,18	4.564	4.789
6	Jawa Timur	2.509	0,20	4.157	0,33	44.112	43.539
7	Aceh	700	0,35	611	0,31	8.055	8.981
8	Sumatera Utara	1.042	0,16	2.284	0,35	21.695	22.319
9	Sumatera Barat	1.512	0,70	709	0,33	8.111	8.498
10	R i a u	460	0,18	858	0,34	9.250	9.229
11	Kep. Riau	370	0,47	120	0,15	2.745	2.718
12	J a m b i	292	0,24	459	0,37	4.850	5.077
13	Sumatera Selatan	773	0,22	1.274	0,37	11.527	11.264
14	Bangka Belitung	193	0,34	279	0,49	1.930	2.038
15	Bengkulu	239	0,28	339	0,39	3.430	3.559
16	Lampung	396	0,13	1.199	0,38	11.087	11.439
17	Kalimantan Barat	1.043	0,46	1.207	0,53	8.210	8.395
18	Kalimantan Tengah	229	0,22	431	0,41	4.420	4.704
19	Kalimantan Selatan	274	0,23	363	0,30	4.629	4.905
20	Kalimantan Timur	543	0,36	362	0,24	5.384	5.354
21	Kalimantan Utara	220	0,74	127	0,43	1.146	1.056
22	Sulawesi Utara	357	0,30	251	0,21	4.840	4.936
23	Gorontalo	295	0,60	115	0,23	2.103	2.130
24	Sulawesi T engah	407	0,32	387	0,30	5.367	5.549
25	Sulawesi Selatan	1.103	0,28	1.640	0,42	14.780	14.812
26	Sulawesi Barat	262	0,43	328	0,54	2.396	2.454
27	Sulawesi T enggara	658	0,53	667	0,53	5.385	5.547
28	M a l u k u	96	0,10	289	0,30	3.979	3.967
29	Maluku Utara	149	0,25	302	0,51	2.478	2.346
30	B a l i	66	0,03	394	0,20	6.194	5.313
31	Nusa Tenggara Barat	498	0,28	672	0,37	6.936	6.863
32	Nusa Tenggara Timur	720	0,23	2.501	0,79	12.145	11.555
33	Papua	917	0,80	809	0,71	4.170	4.121
34	Papua Barat	433	1,00	214	0,49	1.789	1.780
<b>Indonesia</b>		<b>23.449</b>	<b>0,23</b>	<b>38.702</b>	<b>0,39</b>	<b>348.174</b>	<b>347.592</b>



**Tabel : 6**  
**Data Pokok Pendidikan Sekolah Menengah Atas Tiap Provinsi**  
**Tahun 2016/2017**

No.	Provinsi	Sekolah	Siswa Baru	S i s w a	Lulusan	KS + Guru
(1)	(2)	(3)	(4)	(5)	(6)	(7)
1	DKI Jakarta	480	57.444	165.279	48.092	9.954
2	Jawa Barat	1.520	236.896	644.854	167.193	31.906
3	Banten	511	62.190	178.640	47.042	8.939
4	Jawa Tengah	856	139.566	394.564	110.226	24.877
5	DI Yogyakarta	161	18.738	54.067	16.112	4.179
6	Jawa Timur	1.491	184.267	523.500	145.072	32.011
7	Aceh	506	48.452	137.375	38.084	13.884
8	Sumatera Utara	1.043	126.081	362.994	96.721	20.404
9	Sumatera Barat	312	50.536	142.749	41.166	11.185
10	R i a u	422	52.055	146.097	40.182	10.192
11	Kep. Riau	118	14.108	38.589	9.968	2.355
12	J a m b i	221	25.709	74.447	20.011	5.285
13	Sumatera Selatan	584	70.731	201.955	54.852	13.221
14	Bangka Belitung	66	9.123	24.380	6.335	1.455
15	Bengkulu	134	17.305	48.178	12.993	3.570
16	Lampung	471	53.192	149.141	40.112	9.696
17	Kalimantan Barat	402	42.701	115.917	29.670	6.134
18	Kalimantan Tengah	232	19.521	54.006	13.765	4.188
19	Kalimantan Selatan	184	23.418	63.171	16.176	4.230
20	Kalimantan Timur	214	25.085	68.922	17.833	4.262
21	Kalimantan Utara	57	5.706	15.996	4.387	1.100
22	Sulawesi Utara	217	18.963	55.932	15.365	4.037
23	Gorontalo	58	9.642	26.369	6.846	1.631
24	Sulawesi Tengah	204	24.783	69.366	17.717	4.291
25	Sulawesi Selatan	569	80.567	232.753	64.771	14.282
26	Sulawesi Barat	81	9.420	26.669	7.029	1.702
27	Sulawesi Tenggara	284	30.055	87.985	23.913	6.383
28	M a l u k u	263	23.097	69.067	19.198	5.368
29	Maluku Utara	179	12.191	36.314	9.467	2.799
30	B a l i	160	28.885	85.020	24.841	5.562
31	Nusa Tenggara Barat	312	35.763	105.788	28.100	8.538
32	Nusa Tenggara Timur	499	62.725	175.796	47.253	11.641
33	Papua	217	20.042	58.152	15.777	3.674
34	Papua Barat	116	7.808	25.510	6.942	1.937
<b>Indonesia</b>		<b>13.144</b>	<b>1.646.765</b>	<b>4.659.542</b>	<b>1.263.211</b>	<b>294.872</b>



**Tabel : 6 lanjutan**  
**Data Pokok Pendidikan Sekolah Menengah Atas Tiap Provinsi**  
**Tahun 2016/2017**

No.	Provinsi	Mengulang		Putus Sekolah		Rombongan Belajar	Ruang Kelas
		Jumlah	%	Jumlah	%		
(1)	(2)	(3)	(4)	(5)	(6)	(7)	(8)
1	DKI Jakarta	248	0,16	606	0,39	5.534	5.627
2	Jawa Barat	396	0,07	5.626	0,97	19.457	18.515
3	Banten	119	0,07	1.234	0,74	5.581	5.405
4	Jawa Tengah	262	0,07	2.618	0,71	12.930	13.199
5	DI Yogyakarta	57	0,11	260	0,50	2.046	2.109
6	Jawa Timur	804	0,16	3.991	0,81	17.443	16.639
7	Aceh	419	0,31	1.173	0,87	5.377	5.621
8	Sumatera Utara	295	0,09	3.319	0,98	11.098	11.170
9	Sumatera Barat	590	0,43	1.100	0,81	4.955	4.880
10	R i a u	167	0,12	1.011	0,74	4.956	4.905
11	Kep. Riau	107	0,31	222	0,64	1.295	1.292
12	J a m b i	130	0,19	428	0,64	2.540	2.463
13	Sumatera Selatan	336	0,18	1.804	0,96	6.394	6.368
14	Bangka Belitung	48	0,22	257	1,16	824	857
15	Bengkulu	62	0,14	398	0,89	1.730	1.730
16	Lampung	102	0,07	1.331	0,97	5.024	4.939
17	Kalimantan Barat	277	0,26	1.184	1,12	3.727	3.621
18	Kalimantan Tengah	126	0,26	446	0,91	2.086	2.056
19	Kalimantan Selatan	80	0,14	491	0,86	2.217	2.200
20	Kalimantan Timur	138	0,22	383	0,61	2.375	2.248
21	Kalimantan Utara	65	0,57	69	0,48	557	506
22	Sulawesi Utara	212	0,42	311	0,61	2.249	2.236
23	Gorontalo	49	0,20	130	0,52	938	925
24	Sulawesi Tengah	148	0,23	404	0,63	2.412	2.309
25	Sulawesi Selatan	384	0,17	1.384	0,63	7.687	7.476
26	Sulawesi Barat	52	0,21	203	0,83	897	886
27	Sulawesi Tenggara	456	0,55	960	1,16	3.327	3.187
28	M a l u k u	43	0,07	274	0,43	2.650	2.428
29	Maluku Utara	83	0,26	188	0,59	1.401	1.342
30	B a l i	17	0,02	506	0,62	2.695	2.534
31	Nusa Tenggara Barat	136	0,14	1.263	1,27	3.469	3.333
32	Nusa Tenggara Timur	419	0,27	2.256	1,45	6.222	5.482
33	Papua	382	0,74	391	0,75	2.035	1.956
34	Papua Barat	131	0,58	198	0,88	1.034	997
	<b>Indonesia</b>	<b>7.340</b>	<b>0,17</b>	<b>36.419</b>	<b>0,84</b>	<b>155.162</b>	<b>151.441</b>





**Tabel : 7**  
**Data Pokok Pendidikan Sekolah Menengah Kejuruan Tiap Provinsi**  
**Tahun 2016/2017**

No.	Provinsi	Sekolah	Siswa Baru	S i s w a	Lulusan	KS + Guru
(1)	(2)	(3)	(4)	(5)	(6)	(7)
1	DKI Jakarta	585	75.153	213.328	64.325	9.908
2	Jawa Barat	2.705	364.273	990.062	263.488	42.984
3	Banten	642	83.946	237.499	65.394	9.726
4	Jawa Tengah	1.547	269.729	754.327	211.587	42.815
5	DI Yogyakarta	219	30.839	85.210	25.890	6.761
6	Jawa Timur	1.904	260.371	707.743	203.176	40.857
7	Aceh	198	19.233	50.612	12.207	5.653
8	Sumatera Utara	951	103.957	290.893	80.848	17.118
9	Sumatera Barat	199	31.715	82.203	21.906	7.267
10	R i a u	273	31.998	87.109	23.395	6.617
11	Kep. Riau	90	9.832	27.313	7.527	1.839
12	J a m b i	168	16.966	46.243	12.495	3.634
13	Sumatera Selatan	282	39.174	104.022	25.955	6.454
14	Bangka Belitung	54	8.752	23.138	6.469	1.444
15	Bengkulu	90	9.716	26.223	6.932	2.291
16	Lampung	433	48.204	131.692	33.748	7.920
17	Kalimantan Barat	187	23.512	59.016	14.283	3.295
18	Kalimantan Tengah	129	11.744	30.886	7.331	2.522
19	Kalimantan Selatan	121	19.113	52.887	14.869	3.421
20	Kalimantan Timur	214	25.544	72.161	20.905	4.670
21	Kalimantan Utara	28	3.351	8.766	2.281	713
22	Sulawesi Utara	178	17.531	49.679	13.477	3.541
23	Gorontalo	55	7.078	19.492	5.129	1.594
24	Sulawesi Tengah	173	15.586	41.426	10.531	3.246
25	Sulawesi Selatan	428	44.749	128.470	36.095	9.818
26	Sulawesi Barat	121	8.781	25.645	7.300	1.936
27	Sulawesi Tenggara	144	11.190	30.870	7.769	3.043
28	M a l u k u	105	7.397	20.044	4.851	2.248
29	Maluku Utara	111	5.284	16.116	4.485	1.601
30	B a l i	176	32.953	91.249	27.630	5.297
31	Nusa Tenggara Barat	290	25.142	67.222	16.785	6.469
32	Nusa Tenggara Timur	260	27.224	69.820	16.433	5.991
33	Papua	125	11.012	28.978	6.568	2.434
34	Papua Barat	51	4.799	12.569	3.114	972
<b>Indonesia</b>		<b>13.236</b>	<b>1.705.848</b>	<b>4.682.913</b>	<b>1.285.178</b>	<b>276.099</b>



**Tabel : 7 lanjutan**  
**Jumlah Siswa Menurut Jenis Kelamin dan Status Tiap Provinsi**  
**Tahun 2016/2017**

No.	Provinsi	Mengulang		Putus Sekolah		Rombongan Belajar	Ruang Kelas
		Jumlah	%	Jumlah	%		
(1)	(2)	(3)	(4)	(5)	(6)	(7)	(8)
1	DKI Jakarta	324	0,16	2.690	1,33	7.078	6.280
2	Jawa Barat	1.117	0,12	15.952	1,77	32.374	26.895
3	Banten	254	0,11	3.153	1,41	7.740	6.476
4	Jawa Tengah	844	0,12	10.867	1,54	25.002	21.317
5	DI Yogyakarta	145	0,18	1.095	1,35	3.304	2.873
6	Jawa Timur	2.054	0,31	11.067	1,67	24.037	19.334
7	Aceh	313	0,68	481	1,04	2.272	2.133
8	Sumatera Utara	385	0,14	6.154	2,24	10.303	9.939
9	Sumatera Barat	461	0,61	1.340	1,76	3.225	2.667
10	R i a u	167	0,21	1.168	1,45	3.479	3.193
11	Kep. Riau	127	0,50	279	1,11	1.137	1.037
12	J a m b i	128	0,30	372	0,87	1.836	1.806
13	Sumatera Selatan	422	0,45	1.855	1,98	3.541	3.027
14	Bangka Belitung	100	0,47	496	2,32	801	822
15	Bengkulu	107	0,43	463	1,88	1.126	1.098
16	Lampung	85	0,07	2.276	1,92	4.670	4.170
17	Kalimantan Barat	220	0,42	1.457	2,78	2.068	1.905
18	Kalimantan Tengah	80	0,29	545	1,97	1.282	1.305
19	Kalimantan Selatan	83	0,17	779	1,57	1.827	1.661
20	Kalimantan Timur	176	0,26	763	1,11	2.717	2.399
21	Kalimantan Utara	61	0,80	83	1,08	333	283
22	Sulawesi Utara	160	0,34	927	1,99	2.305	2.151
23	Gorontalo	116	0,63	328	1,77	831	812
24	Sulawesi Tengah	162	0,43	560	1,48	1.878	1.757
25	Sulawesi Selatan	256	0,21	2.080	1,72	5.382	4.929
26	Sulawesi Barat	37	0,16	305	1,30	1.066	990
27	Sulawesi Tenggara	84	0,29	525	1,83	1.512	1.397
28	M a l u k u	69	0,42	98	0,60	1.032	900
29	Maluku Utara	14	0,09	175	1,18	839	738
30	B a l i	34	0,04	892	1,07	2.945	2.257
31	Nusa Tenggara Barat	260	0,43	1.514	2,49	2.631	2.258
32	Nusa Tenggara Timur	149	0,25	1.485	2,45	2.941	2.587
33	Papua	595	2,38	318	1,27	1.309	1.229
34	Papua Barat	255	2,44	202	1,93	563	550
	<b>Indonesia</b>	<b>9.844</b>	<b>0,23</b>	<b>72.744</b>	<b>1,68</b>	<b>165.386</b>	<b>143.175</b>



**Tabel : 8**  
**Jumlah Siswa Menurut Jenis Kelamin dan Status Tiap Provinsi**  
**Tahun 2016/2017**

No.	Provinsi	TK		PLB		SD	
		Laki2	Perempuan	Laki-laki	Perempuan	Laki-laki	Perempuan
(1)	(2)	(3)	(4)	(5)	(6)	(7)	(8)
1	D.K.I. Jakarta	68.561	64.041	3.384	2.226	422.626	392.692
2	Jawa Barat	215.919	200.327	12.467	8.575	2.338.436	2.178.138
3	Banten	104.191	75.593	2.917	1.848	622.718	575.754
4	Jawa Tengah	394.646	317.470	9.062	6.426	1.503.785	1.375.085
5	D.I. Yogyakarta	53.044	45.494	2.957	1.936	152.327	140.263
6	Jawa Timur	494.212	453.426	10.297	7.119	1.493.030	1.371.666
7	Aceh	69.740	42.425	1.647	1.090	253.491	230.405
8	Sumatera Utara	104.871	94.789	2.486	1.726	914.917	842.799
9	Sumatera Barat	49.984	43.755	3.879	2.284	340.857	307.354
10	Riau	60.739	47.025	1.659	995	418.694	381.234
11	Kepulauan Riau	24.741	22.776	670	440	117.009	107.634
12	Jambi	24.808	20.330	926	568	204.170	186.693
13	Sumatera Selatan	47.073	33.638	1.422	849	489.405	448.110
14	Bangka Belitung	19.857	12.752	518	338	83.095	75.574
15	Bengkulu	20.167	18.836	745	476	115.229	103.433
16	Lampung	66.618	57.839	947	673	441.014	405.387
17	Kalimantan Barat	35.816	23.649	740	426	316.209	284.867
18	Kalimantan Tengah	35.825	29.880	610	393	151.861	137.825
19	Kalimantan Selatan	59.103	45.896	1.305	812	200.125	181.825
20	Kalimantan Timur	33.257	22.446	1.304	684	216.175	197.034
21	Kalimantan Utara	7.207	6.522	221	120	41.513	37.576
22	Sulawesi Utara	37.757	33.626	670	441	131.623	119.353
23	Gorontalo	16.924	13.943	546	347	67.083	61.864
24	Sulawesi Tengah	50.504	37.975	805	471	185.628	169.523
25	Sulawesi Selatan	143.508	80.598	2.799	1.921	495.019	453.590
26	Sulawesi Barat	12.113	10.489	602	449	86.953	78.039
27	Sulawesi Tenggara	54.474	47.287	1.503	979	172.495	158.454
28	Maluku	13.218	9.755	529	311	120.368	108.478
29	Maluku Utara	12.867	11.238	494	362	81.695	73.933
30	Bali	45.234	42.136	1.120	708	209.758	192.795
31	Nusa Tenggara Barat	60.051	58.405	1.680	1.154	267.335	244.962
32	Nusa Tenggara Timur	44.824	42.846	1.405	1.024	421.976	377.356
33	Papua	22.032	20.487	338	240	223.410	185.352
34	Papua Barat	7.783	6.447	108	71	70.039	62.963
	<b>Indonesia</b>	<b>2.511.668</b>	<b>2.094.141</b>	<b>72.762</b>	<b>48.482</b>	<b>13.370.068</b>	<b>12.248.010</b>



**Tabel : 8 lanjutan**  
**Jumlah Siswa Menurut Jenis Kelamin dan Status Tiap Provinsi**  
**Tahun 2016/2017**

No.	Provinsi	SMP		SMA		SMK	
		Laki-laki	Perempuan	Laki-laki	Perempuan	Laki-laki	Perempuan
(1)	(2)	(3)	(4)	(5)	(6)	(7)	(8)
1	D.K.I. Jakarta	186.795	182.518	77.253	88.026	109.906	103.422
2	Jawa Barat	919.770	882.184	278.455	366.399	565.759	424.303
3	Banten	222.182	206.910	81.831	96.809	133.302	104.197
4	Jawa Tengah	616.041	593.200	150.067	244.497	436.475	317.852
5	D.I. Yogyakarta	66.439	62.866	22.536	31.531	47.923	37.287
6	Jawa Timur	661.384	606.105	230.942	292.558	418.247	289.496
7	Aceh	102.222	93.232	62.818	74.557	30.421	20.191
8	Sumatera Utara	340.548	324.591	161.770	201.224	165.238	125.655
9	Sumatera Barat	109.146	107.054	60.098	82.651	47.797	34.406
10	Riau	132.111	128.076	65.203	80.894	51.139	35.970
11	Kepulauan Riau	42.464	41.054	17.444	21.145	15.897	11.416
12	Jambi	64.601	61.962	34.419	40.028	26.326	19.917
13	Sumatera Selatan	178.882	176.369	92.622	109.333	60.685	43.337
14	Bangka Belitung	29.943	29.437	10.825	13.555	12.339	10.799
15	Bengkulu	45.031	43.777	21.599	26.579	15.768	10.455
16	Lampung	161.350	157.107	65.583	83.558	74.414	57.278
17	Kalimantan Barat	117.346	118.843	53.637	62.280	31.840	27.176
18	Kalimantan Tengah	54.623	53.581	25.877	28.129	17.754	13.132
19	Kalimantan Selatan	62.655	58.610	29.073	34.098	30.688	22.199
20	Kalimantan Timur	79.784	75.887	30.672	38.250	41.613	30.548
21	Kalimantan Utara	15.626	15.263	7.525	8.471	4.748	4.018
22	Sulawesi Utara	62.024	59.839	27.051	28.881	25.477	24.202
23	Gorontalo	24.718	25.926	11.370	14.999	10.677	8.815
24	Sulawesi Tengah	65.106	66.236	31.885	37.481	21.762	19.664
25	Sulawesi Selatan	195.434	195.418	102.426	130.327	74.358	54.112
26	Sulawesi Barat	30.858	32.385	11.892	14.777	13.422	12.223
27	Sulawesi Tenggara	64.948	63.755	41.806	46.179	17.129	13.741
28	Maluku	49.751	46.759	33.652	35.415	10.981	9.063
29	Maluku Utara	30.008	29.243	17.592	18.722	8.478	7.638
30	Bali	102.563	94.282	43.397	41.623	49.623	41.626
31	Nusa Tenggara Barat	94.687	87.274	50.696	55.092	40.610	26.612
32	Nusa Tenggara Timur	163.647	166.145	79.325	96.471	38.862	30.958
33	Papua	66.448	53.812	30.972	27.180	18.263	10.715
34	Papua Barat	24.221	22.360	12.703	12.807	7.691	4.878
<b>Indonesia</b>		<b>5.183.356</b>	<b>4.962.060</b>	<b>2.075.016</b>	<b>2.584.526</b>	<b>2.675.612</b>	<b>2.007.301</b>



**Tabel : 9**  
**Jumlah Siswa Menurut Tingkat, Jenjang Pendidikan dan Status**  
**Tahun 2016/2017**

No.	Jenjang Pendidikan	Tingkat						Jumlah
		I	II	III	IV	V	VI	
(1)		(3)	(4)	(5)	(6)	(7)	(8)	(9)
1.	<b>SD</b>	<b>4.322.763</b>	<b>4.277.901</b>	<b>4.317.240</b>	<b>4.343.357</b>	<b>4.232.129</b>	<b>4.124.688</b>	<b>25.618.078</b>
	a. Negeri	3.753.886	3.711.605	3.758.850	3.803.686	3.731.639	3.668.493	<b>22.428.159</b>
	b. Swasta	568.877	566.296	558.390	539.671	500.490	456.195	<b>3.189.919</b>
2.		<b>VII</b>	<b>VIII</b>	<b>IX</b>				
	<b>SMP</b>	<b>3.446.522</b>	<b>3.433.466</b>	<b>3.265.428</b>				<b>10.145.416</b>
	a. Negeri	2.593.917	2.559.339	2.432.068				7.585.324
	b. Swasta	852.605	874.127	833.360				2.560.092
3.		<b>X</b>	<b>XI</b>	<b>XII</b>	<b>XIII</b>			
	<b>SMA</b>	<b>1.650.654</b>	<b>1.584.211</b>	<b>1.424.677</b>				<b>4.659.542</b>
	a. Negeri	1.221.680	1.153.588	1.041.487				3.416.755
	b. Swasta	428.974	430.623	383.190				1.242.787
4.	<b>SMK</b>	<b>1.711.097</b>	<b>1.611.018</b>	<b>1.356.576</b>	<b>4.222</b>			<b>4.682.913</b>
	a. Negeri	748.637	676.033	575.668	3.717			2.004.055
	b. Swasta	962.460	934.985	780.908	505			2.678.858

**Grafik : 4**  
**Jumlah Siswa menurut Tingkat dan Status sekolah**  
**Tahun 2016/2017**

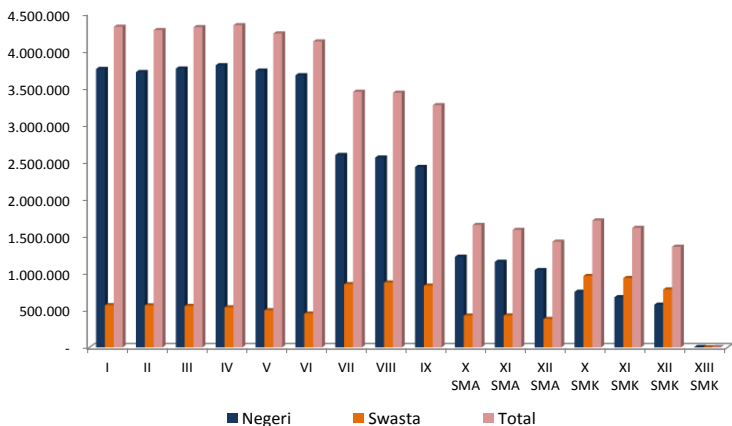



# DIAGRAM 1 ARUS SISWA SEKOLAH DASAR SAMPAI SEKOLAH MENENGAH TAHUN 2016/2017

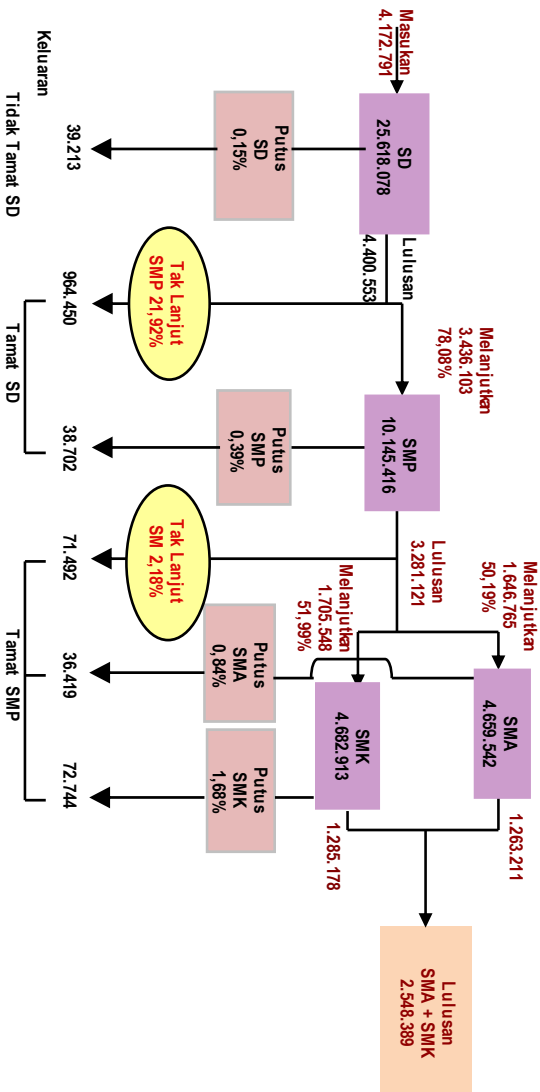



**Tabel : 10**  
**Jumlah Siswa Putus Sekolah Jenjang Sekolah Dasar**  
**Menurut Tingkat Tiap Provinsi**  
**Tahun 2016/2017**

No.	Provinsi	I	II	III	IV	V	VI	Jumlah
(1)	(2)	(3)	(4)	(5)	(6)	(7)	(8)	(9)
1	DKI Jakarta	204	154	160	175	166	123	982
2	Jawa Barat	896	827	704	658	765	847	4.697
3	Banten	350	324	254	248	238	255	1.669
4	Jawa Tengah	474	355	351	322	398	305	2.205
5	DI Yogyakarta	24	36	31	30	28	21	170
6	Jawa Timur	337	323	266	250	302	330	1.808
7	Aceh	227	218	168	140	140	128	1.021
8	Sumatera Utara	826	775	699	578	621	576	4.075
9	Sumatera Barat	211	134	112	135	172	93	857
10	R i a u	319	253	211	190	233	195	1.401
11	Kep. Riau	70	59	48	35	38	28	278
12	J a m b i	146	144	162	114	107	98	771
13	Sumatera Selatan	433	392	316	259	313	235	1.948
14	Bangka Belitung	58	48	30	37	55	32	260
15	Bengkulu	97	94	66	72	76	46	451
16	Lampung	296	237	223	178	222	194	1.350
17	Kalimantan Barat	332	236	196	207	234	271	1.476
18	Kalimantan Tengah	134	135	104	84	98	120	675
19	Kalimantan Selatan	113	75	72	95	97	78	530
20	Kalimantan Timur	118	59	59	61	78	63	438
21	Kalimantan Utara	25	39	26	13	21	22	146
22	Sulawesi Utara	46	69	39	35	37	51	277
23	Gorontalo	39	27	56	46	88	34	290
24	Sulawesi Tengah	141	125	172	124	150	102	814
25	Sulawesi Selatan	375	422	363	409	495	486	2.550
26	Sulawesi Barat	54	54	79	78	103	83	451
27	Sulawesi Tenggara	143	179	157	134	176	211	1.000
28	M a l u k u	90	101	68	34	52	36	381
29	Maluku Utara	88	123	89	85	59	78	522
30	B a l i	37	37	38	31	25	20	188
31	Nusa Tenggara Barat	169	127	114	108	86	98	702
32	Nusa Tenggara Timur	519	317	296	258	300	290	1.980
33	Papua	559	466	366	325	357	283	2.356
34	Papua Barat	107	98	90	73	68	58	494
	<b>Indonesia</b>	<b>8.057</b>	<b>7.062</b>	<b>6.185</b>	<b>5.621</b>	<b>6.398</b>	<b>5.890</b>	<b>39.213</b>



**Tabel : 11**  
**Jumlah Siswa Putus Sekolah Jenjang Sekolah Menengah Pertama**  
**Menurut Tingkat Tiap Provinsi**  
**Tahun 2016/2017**

No.	Provinsi	VII	VIII	IX	Jumlah
(1)	(2)	(3)	(4)	(5)	(6)
1	DKI Jakarta	281	379	420	1.080
2	Jawa Barat	1.772	2.842	4.021	8.635
3	Banten	432	631	664	1.727
4	Jawa Tengah	1.161	1.295	1.217	3.673
5	DI Yogyakarta	58	106	75	239
6	Jawa Timur	1.103	1.400	1.654	4.157
7	Aceh	116	249	246	611
8	Sumatera Utara	590	745	949	2.284
9	Sumatera Barat	266	240	203	709
10	R i a u	229	293	336	858
11	Kep. Riau	45	51	24	120
12	J a m b i	119	150	190	459
13	Sumatera Selatan	344	497	433	1.274
14	Bangka Belitung	100	123	56	279
15	Bengkulu	73	106	160	339
16	Lampung	279	406	514	1.199
17	Kalimantan Barat	366	443	398	1.207
18	Kalimantan Tengah	97	196	138	431
19	Kalimantan Selatan	103	125	135	363
20	Kalimantan Timur	107	158	97	362
21	Kalimantan Utara	52	56	19	127
22	Sulawesi Utara	73	91	87	251
23	Gorontalo	37	55	23	115
24	Sulawesi Tengah	80	141	166	387
25	Sulawesi Selatan	279	462	899	1.640
26	Sulawesi Barat	42	116	170	328
27	Sulawesi Tenggara	125	217	325	667
28	M a l u k u	58	91	140	289
29	Maluku Utara	48	81	173	302
30	B a l i	94	142	158	394
31	Nusa Tenggara Barat	90	236	346	672
32	Nusa Tenggara Timur	583	868	1.050	2.501
33	Papua	187	261	361	809
34	Papua Barat	59	53	102	214
<b>Indonesia</b>		<b>9.448</b>	<b>13.305</b>	<b>15.949</b>	<b>38.702</b>





**Tabel : 12**  
**Jumlah Siswa Putus Sekolah Jenjang Sekolah Menengah Atas**  
**Menurut Tingkat Tiap Provinsi**  
**Tahun 2016/2017**

No.	Provinsi	X	XI	XII	Jumlah
(1)	(2)	(3)	(4)	(5)	(6)
1	DKI Jakarta	316	215	75	606
2	Jawa Barat	1.882	1.981	1.763	5.626
3	Banten	415	401	418	1.234
4	Jawa Tengah	937	812	869	2.618
5	DI Yogyakarta	73	100	87	260
6	Jawa Timur	1.072	1.332	1.587	3.991
7	Aceh	425	417	331	1.173
8	Sumatera Utara	1.152	1.081	1.086	3.319
9	Sumatera Barat	484	376	240	1.100
10	R i a u	422	318	271	1.011
11	Kep. Riau	115	60	47	222
12	J a m b i	134	147	147	428
13	Sumatera Selatan	592	525	687	1.804
14	Bangka Belitung	114	101	42	257
15	Bengkulu	132	129	137	398
16	Lampung	424	392	515	1.331
17	Kalimantan Barat	429	438	317	1.184
18	Kalimantan Tengah	135	151	160	446
19	Kalimantan Selatan	196	174	121	491
20	Kalimantan Timur	97	130	156	383
21	Kalimantan Utara	32	29	8	69
22	Sulawesi Utara	109	92	110	311
23	Gorontalo	61	32	37	130
24	Sulawesi Tengah	168	120	116	404
25	Sulawesi Selatan	439	336	609	1.384
26	Sulawesi Barat	54	86	63	203
27	Sulawesi Tenggara	299	229	432	960
28	M a l u k u	57	102	115	274
29	Maluku Utara	34	63	91	188
30	B a l i	126	187	193	506
31	Nusa Tenggara Barat	223	394	646	1.263
32	Nusa Tenggara Timur	791	618	847	2.256
33	Papua	110	120	161	391
34	Papua Barat	76	55	67	198
<b>Indonesia</b>		<b>12.125</b>	<b>11.743</b>	<b>12.551</b>	<b>36.419</b>



**Tabel : 13**  
**Jumlah Siswa Putus Sekolah Jenjang Sekolah Menengah Kejuruan**  
**Menurut Tingkat Tiap Provinsi**  
**Tahun 2016/2017**

No.	Provinsi	X	XI	XII	XIII	Jumlah
(1)	(2)	(3)	(4)	(5)	(6)	(7)
1	DKI Jakarta	1.074	1.026	590	-	2.690
2	Jawa Barat	4.171	5.910	5.863	8	15.952
3	Banten	874	1.180	1.098	1	3.153
4	Jawa Tengah	3.193	3.888	3.782	4	10.867
5	DI Yogyakarta	359	386	345	5	1.095
6	Jawa Timur	2.918	4.239	3.903	7	11.067
7	Aceh	138	173	170	-	481
8	Sumatera Utara	1.498	2.107	2.549	-	6.154
9	Sumatera Barat	543	540	257	-	1.340
10	R i a u	351	448	369	-	1.168
11	Kep. Riau	94	117	68	-	279
12	J a m b i	139	122	111	-	372
13	Sumatera Selatan	562	810	483	-	1.855
14	Bangka Belitung	194	161	141	-	496
15	Bengkulu	99	191	173	-	463
16	Lampung	681	891	704	-	2.276
17	Kalimantan Barat	343	650	464	-	1.457
18	Kalimantan Tengah	153	223	169	-	545
19	Kalimantan Selatan	232	312	235	-	779
20	Kalimantan Timur	180	217	366	-	763
21	Kalimantan Utara	44	34	5	-	83
22	Sulawesi Utara	293	321	313	-	927
23	Gorontalo	149	95	84	-	328
24	Sulawesi Tengah	129	184	247	-	560
25	Sulawesi Selatan	434	687	959	-	2.080
26	Sulawesi Barat	89	102	114	-	305
27	Sulawesi Tenggara	116	151	258	-	525
28	M a l u k u	25	43	30	-	98
29	Maluku Utara	25	25	125	-	175
30	B a l i	189	334	369	-	892
31	Nusa Tenggara Barat	326	482	706	-	1.514
32	Nusa Tenggara Timur	454	619	412	-	1.485
33	Papua	131	125	62	-	318
34	Papua Barat	101	45	56	-	202
<b>Indonesia</b>		<b>20.301</b>	<b>26.838</b>	<b>25.580</b>	<b>25</b>	<b>72.744</b>



**Grafik : 5**  
**Grafik Mengulang Menurut Jenis Kelamin**  
**Tahun 2016/2017**

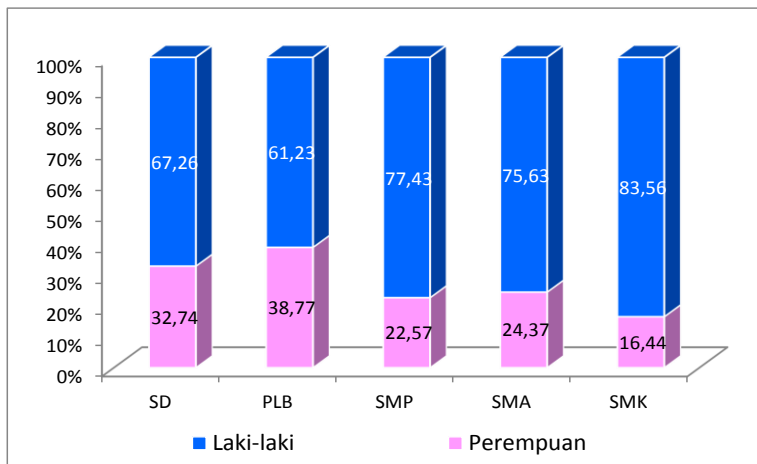

**Grafik : 6**  
**Grafik Siswa Putus Sekolah Menurut Jenis Kelamin**  
**Tahun 2016/2017**

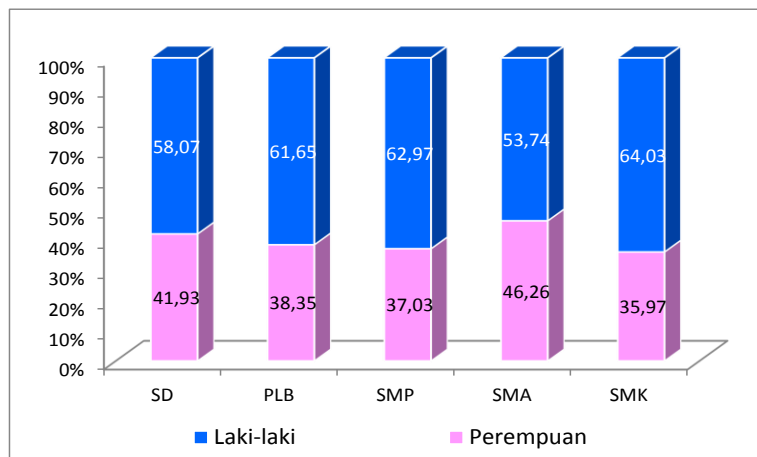



**Tabel : 14**  
**Jumlah Siswa Mengulang Jenjang Sekolah Dasar**  
**Menurut Tingkat Tiap Provinsi**  
**Tahun 2016/2017**

No.	Provinsi	I	II	III	IV	V	VI	Jumlah
(1)	(2)	(3)	(4)	(5)	(6)	(7)	(8)	(9)
1	DKI Jakarta	1.113	1.000	888	761	582	11	4.355
2	Jawa Barat	9.155	4.095	3.008	1.642	1.316	68	19.284
3	Banten	5.116	2.411	1.677	724	467	11	10.406
4	Jawa Tengah	19.870	11.626	10.233	6.981	4.403	54	53.167
5	DI Yogyakarta	999	635	593	475	373	5	3.080
6	Jawa Timur	13.055	5.708	4.132	2.589	1.743	67	27.294
7	Aceh	2.032	1.138	968	542	311	17	5.008
8	Sumatera Utara	7.486	3.725	2.804	1.652	1.243	170	17.080
9	Sumatera Barat	6.619	4.203	4.108	3.315	2.416	48	20.709
10	Riau	5.420	2.838	2.221	1.360	892	18	12.749
11	Kep. Riau	1.019	573	456	358	214	1	2.621
12	Jambi	2.721	1.289	909	542	325	15	5.801
13	Sumatera Selatan	6.393	3.384	2.798	1.539	979	47	15.140
14	Bangka Belitung	1.540	940	978	633	451	-	4.542
15	Bengkulu	1.802	898	717	459	349	-	4.225
16	Lampung	5.385	2.420	1.848	1.041	589	14	11.297
17	Kalimantan Barat	10.304	5.258	4.197	2.824	1.832	30	24.445
18	Kalimantan Tengah	2.815	1.235	877	580	331	16	5.854
19	Kalimantan Selatan	4.452	2.066	1.527	862	458	14	9.379
20	Kalimantan Timur	2.709	1.415	1.051	593	437	6	6.211
21	Kalimantan Utara	693	275	225	123	114	2	1.432
22	Sulawesi Utara	831	418	340	266	235	17	2.107
23	Gorontalo	1.725	978	759	543	461	38	4.504
24	Sulawesi Tengah	2.848	1.356	1.177	810	558	27	6.776
25	Sulawesi Selatan	4.531	2.431	2.140	1.267	1.100	228	11.697
26	Sulawesi Barat	871	555	545	317	249	17	2.554
27	Sulawesi Tenggara	2.000	1.168	1.213	847	679	128	6.035
28	Maluku	2.177	784	634	400	248	30	4.273
29	Maluku Utara	1.228	508	437	288	238	30	2.729
30	Bali	1.000	562	392	168	69	2	2.193
31	Nusa Tenggara Barat	2.789	1.287	1.112	618	503	52	6.361
32	Nusa Tenggara Timur	12.548	6.618	5.662	3.876	2.572	52	31.328
33	Papua	4.866	2.178	2.025	1.363	1.511	227	12.170
34	Papua Barat	1.860	841	745	451	487	25	4.409
<b>Indonesia</b>		<b>149.972</b>	<b>76.816</b>	<b>63.396</b>	<b>40.809</b>	<b>28.735</b>	<b>1.487</b>	<b>361.215</b>



**Tabel : 15**  
**Jumlah Siswa Mengulang Jenjang Sekolah Menengah Pertama**  
**Menurut Tingkat Tiap Provinsi**  
**Tahun 2016/2017**

No.	Provinsi	VII	VIII	IX	Jumlah
(1)	(2)	(3)	(4)	(5)	(6)
1	DKI Jakarta	631	716	7	1.354
2	Jawa Barat	788	1.226	90	2.104
3	Banten	292	406	17	715
4	Jawa Tengah	1.015	1.192	81	2.288
5	DI Yogyakarta	91	132	9	232
6	Jawa Timur	1.025	1.329	155	2.509
7	Aceh	265	325	110	700
8	Sumatera Utara	511	430	101	1.042
9	Sumatera Barat	859	627	26	1.512
10	R i a u	227	224	9	460
11	Kep. Riau	204	159	7	370
12	J a m b i	118	145	29	292
13	Sumatera Selatan	326	404	43	773
14	Bangka Belitung	75	118	-	193
15	Bengkulu	93	114	32	239
16	Lampung	205	163	28	396
17	Kalimantan Barat	472	548	23	1.043
18	Kalimantan Tengah	118	94	17	229
19	Kalimantan Selatan	152	102	20	274
20	Kalimantan Timur	252	284	7	543
21	Kalimantan Utara	103	112	5	220
22	Sulawesi Utara	134	189	34	357
23	Gorontalo	165	115	15	295
24	Sulawesi Tengah	153	185	69	407
25	Sulawesi Selatan	443	403	257	1.103
26	Sulawesi Barat	89	60	113	262
27	Sulawesi Tenggara	185	146	327	658
28	M a l u k u	35	56	5	96
29	Maluku Utara	81	42	26	149
30	B a l i	30	36	-	66
31	Nusa Tenggara Barat	228	216	54	498
32	Nusa Tenggara Timur	372	306	42	720
33	Papua	445	369	103	917
34	Papua Barat	237	168	28	433
	<b>Indonesia</b>	<b>10.419</b>	<b>11.141</b>	<b>1.889</b>	<b>23.449</b>



**Tabel : 16**  
**Jumlah Siswa Mengulang Jenjang Sekolah Menengah Atas**  
**Menurut Tingkat Tiap Provinsi**  
**Tahun 2016/2017**

No.	Provinsi	X	XI	XII	Jumlah
(1)	(2)	(3)	(4)	(5)	(6)
1	DKI Jakarta	171	70	7	248
2	Jawa Barat	206	184	6	396
3	Banten	61	51	7	119
4	Jawa Tengah	163	97	2	262
5	DI Yogyakarta	32	22	3	57
6	Jawa Timur	407	365	32	804
7	Aceh	230	159	30	419
8	Sumatera Utara	140	115	40	295
9	Sumatera Barat	406	182	2	590
10	R i a u	116	45	6	167
11	Kep. Riau	71	35	1	107
12	J a m b i	80	48	2	130
13	Sumatera Selatan	204	108	24	336
14	Bangka Belitung	35	13	-	48
15	Bengkulu	25	33	4	62
16	Lampung	59	34	9	102
17	Kalimantan Barat	169	105	3	277
18	Kalimantan Tengah	75	45	6	126
19	Kalimantan Selatan	44	36	-	80
20	Kalimantan Timur	70	64	4	138
21	Kalimantan Utara	15	49	1	65
22	Sulawesi Utara	94	94	24	212
23	Gorontalo	40	8	1	49
24	Sulawesi Tengah	82	53	13	148
25	Sulawesi Selatan	174	116	94	384
26	Sulawesi Barat	17	35	-	52
27	Sulawesi Tenggara	104	88	264	456
28	M a l u k u	10	32	1	43
29	Maluku Utara	34	29	20	83
30	B a l i	9	7	1	17
31	Nusa Tenggara Barat	73	48	15	136
32	Nusa Tenggara Timur	202	177	40	419
33	Papua	201	142	39	382
34	Papua Barat	70	38	23	131
	<b>Indonesia</b>	<b>3.889</b>	<b>2.727</b>	<b>724</b>	<b>7.340</b>



**Tabel : 17**  
**Jumlah Siswa Mengulang Jenjang Sekolah Menengah Kejuruan**  
**Menurut Tingkat Tiap Provinsi**  
**Tahun 2016/2017**

No.	Provinsi	X	XI	XII	XIII	Jumlah
(1)	(2)	(3)	(4)	(5)	(6)	(7)
1	DKI Jakarta	154	130	40	-	324
2	Jawa Barat	580	484	53	-	1.117
3	Banten	160	94	-	-	254
4	Jawa Tengah	399	417	28	-	844
5	DI Yogyakarta	61	73	11	-	145
6	Jawa Timur	1.143	829	79	3	2.054
7	Aceh	176	118	19	-	313
8	Sumatera Utara	169	186	30	-	385
9	Sumatera Barat	354	98	9	-	461
10	R i a u	97	52	18	-	167
11	Kep. Riau	58	41	28	-	127
12	J a m b i	70	54	4	-	128
13	Sumatera Selatan	260	153	9	-	422
14	Bangka Belitung	84	16	-	-	100
15	Bengkulu	49	47	11	-	107
16	Lampung	43	25	17	-	85
17	Kalimantan Barat	119	91	10	-	220
18	Kalimantan Tengah	44	27	9	-	80
19	Kalimantan Selatan	51	30	2	-	83
20	Kalimantan Timur	73	102	1	-	176
21	Kalimantan Utara	48	12	1	-	61
22	Sulawesi Utara	61	91	8	-	160
23	Gorontalo	73	42	1	-	116
24	Sulawesi Tengah	71	64	27	-	162
25	Sulawesi Selatan	137	81	38	-	256
26	Sulawesi Barat	21	3	13	-	37
27	Sulawesi Tenggara	32	24	28	-	84
28	M a l u k u	35	30	4	-	69
29	Maluku Utara	5	5	4	-	14
30	B a l i	20	14	-	-	34
31	Nusa Tenggara Barat	161	80	19	-	260
32	Nusa Tenggara Timur	72	60	17	-	149
33	Papua	272	281	42	-	595
34	Papua Barat	97	123	35	-	255
	<b>Indonesia</b>	<b>5.249</b>	<b>3.977</b>	<b>615</b>	<b>3</b>	<b>9.844</b>



**Grafik : 7**

**Perkembangan Jumlah Siswa Putus Sekolah Menurut Jenjang Pendidikan  
Tahun 2016/2017**

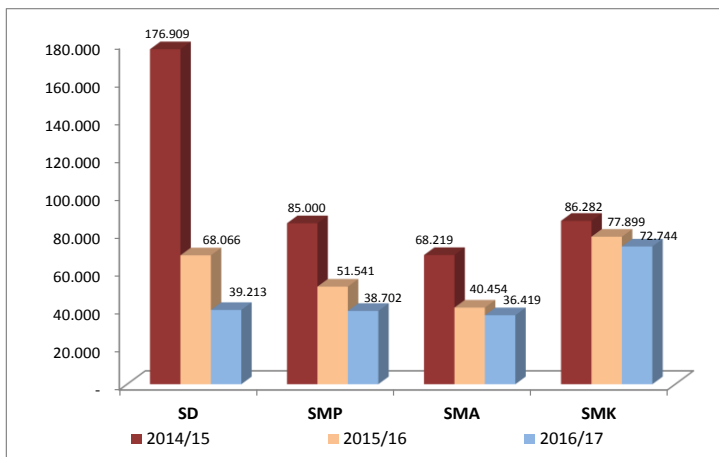

**Grafik : 8**

**Perkembangan Jumlah Siswa Mengulang Menurut Jenjang Pendidikan  
Tahun 2016/2017**

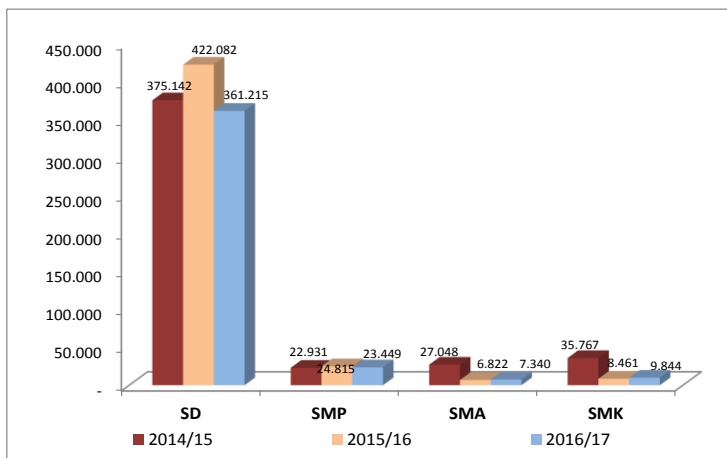





**Tabel : 18**  
**Jumlah Kepala Sekolah + Guru Taman Kanak-kanak**  
**Menurut Ijazah Tertinggi Tiap Provinsi**  
**Tahun 2016/2017**

No.	Provinsi	< S1	> S1	JUMLAH	PERSENTASE	
					< S1	> = S1
(1)	(2)	(3)	(4)	(5)	(6)	(7)
1	DKI Jakarta	3.479	6.173	9.652	36,04	63,96
2	Jawa Barat	15.823	18.557	34.380	46,02	53,98
3	Banten	3.811	5.808	9.619	39,62	60,38
4	Jawa Tengah	23.567	24.021	47.588	49,52	50,48
5	DI Yogyakarta	3.102	6.141	9.243	33,56	66,44
6	Jawa Timur	26.396	42.410	68.806	38,36	61,64
7	Aceh	7.005	4.000	11.005	63,65	36,35
8	Sumatera Utara	3.590	5.365	8.955	40,09	59,91
9	Sumatera Barat	4.092	3.547	7.639	53,57	46,43
10	R i a u	5.436	3.205	8.641	62,91	37,09
11	Kep. Riau	2.045	879	2.924	69,94	30,06
12	J a m b i	2.725	1.648	4.373	62,31	37,69
13	Sumatera Selatan	4.647	3.310	7.957	58,40	41,60
14	Bangka Belitung	1.102	850	1.952	56,45	43,55
15	Bengkulu	1.604	2.007	3.611	44,42	55,58
16	Lampung	5.737	5.582	11.319	50,68	49,32
17	Kalimantan Barat	1.730	1.480	3.210	53,89	46,11
18	Kalimantan Tengah	3.086	2.437	5.523	55,88	44,12
19	Kalimantan Selatan	5.331	4.873	10.204	52,24	47,76
20	Kalimantan Timur	2.611	3.106	5.717	45,67	54,33
21	Kalimantan Utara	609	271	880	69,20	30,80
22	Sulawesi Utara	1.787	931	2.718	65,75	34,25
23	Gorontalo	1.114	950	2.064	53,97	46,03
24	Sulawesi Tengah	4.418	1.850	6.268	70,49	29,51
25	Sulawesi Selatan	5.251	8.834	14.085	37,28	62,72
26	Sulawesi Barat	1.404	817	2.221	63,21	36,79
27	Sulawesi Tenggara	3.586	1.966	5.552	64,59	35,41
28	M a l u k u	917	331	1.248	73,48	26,52
29	Maluku Utara	911	423	1.334	68,29	31,71
30	B a l i	2.381	3.700	6.081	39,15	60,85
31	Nusa Tenggara Barat	3.200	4.500	7.700	41,56	58,44
32	Nusa Tenggara Timur	2.732	1.130	3.862	70,74	29,26
33	Papua	1.333	682	2.015	66,15	33,85
34	Papua Barat	464	292	756	61,38	38,62
<b>Indonesia</b>		<b>157.026</b>	<b>172.076</b>	<b>329.102</b>	<b>47,71</b>	<b>52,29</b>



**Tabel : 19**  
**Jumlah Kepala Sekolah + Guru Sekolah Luar Biasa**  
**Menurut Ijazah Tertinggi Tiap Provinsi**  
**Tahun 2016/2017**

No.	Provinsi	< S1	> S1	JUMLAH	PERSENTASE	
					< S1	> = S1
(1)	(2)	(3)	(4)	(5)	(6)	(7)
1	DKI Jakarta	146	991	1.137	12,84	87,16
2	Jawa Barat	324	3.969	4.293	7,55	92,45
3	Banten	155	851	1.006	15,41	84,59
4	Jawa Tengah	282	2.560	2.842	9,92	90,08
5	DI Yogyakarta	78	1.210	1.288	6,06	93,94
6	Jawa Timur	331	3.270	3.601	9,19	90,81
7	Aceh	128	556	684	18,71	81,29
8	Sumatera Utara	113	518	631	17,91	82,09
9	Sumatera Barat	183	1.101	1.284	14,25	85,75
10	R i a u	94	381	475	19,79	80,21
11	Kep. Riau	21	167	188	11,17	88,83
12	J a m b i	38	266	304	12,50	87,50
13	Sumatera Selatan	67	381	448	14,96	85,04
14	Bangka Belitung	47	99	146	32,19	67,81
15	Bengkulu	37	199	236	15,68	84,32
16	Lampung	99	255	354	27,97	72,03
17	Kalimantan Barat	44	155	199	22,11	77,89
18	Kalimantan Tengah	16	208	224	7,14	92,86
19	Kalimantan Selatan	51	486	537	9,50	90,50
20	Kalimantan Timur	54	292	346	15,61	84,39
21	Kalimantan Utara	10	35	45	22,22	77,78
22	Sulawesi Utara	24	205	229	10,48	89,52
23	Gorontalo	24	177	201	11,94	88,06
24	Sulawesi Tengah	62	173	235	26,38	73,62
25	Sulawesi Selatan	206	912	1.118	18,43	81,57
26	Sulawesi Barat	63	152	215	29,30	70,70
27	Sulawesi Tenggara	150	336	486	30,86	69,14
28	M a l u k u	38	107	145	26,21	73,79
29	Maluku Utara	73	152	225	32,44	67,56
30	B a l i	24	336	360	6,67	93,33
31	Nusa Tenggara Barat	85	481	566	15,02	84,98
32	Nusa Tenggara Timur	117	370	487	24,02	75,98
33	Papua	20	78	98	20,41	79,59
34	Papua Barat	3	21	24	12,50	87,50
<b>Indonesia</b>		<b>3.207</b>	<b>21.450</b>	<b>24.657</b>	<b>13,01</b>	<b>86,99</b>



**Tabel : 20**  
**Jumlah Kepala Sekolah + Guru Sekolah Dasar**  
**Menurut Ijazah Tertinggi Tiap Provinsi**  
**Tahun 2016/2017**

No.	Provinsi	< S1	> S1	JUMLAH	PERSENTASE	
					< S1	> = S1
(1)	(2)	(3)	(4)	(5)	(6)	(7)
1	DKI Jakarta	2.950	33.027	35.977	8,20	91,80
2	Jawa Barat	16.968	196.826	213.794	7,94	92,06
3	Banten	5.990	50.406	56.396	10,62	89,38
4	Jawa Tengah	14.540	168.394	182.934	7,95	92,05
5	DI Yogyakarta	1.922	18.083	20.005	9,61	90,39
6	Jawa Timur	16.886	189.045	205.931	8,20	91,80
7	Aceh	11.099	36.662	47.761	23,24	76,76
8	Sumatera Utara	25.604	80.125	105.729	24,22	75,78
9	Sumatera Barat	4.552	39.569	44.121	10,32	89,68
10	R i a u	8.285	41.425	49.710	16,67	83,33
11	Kep. Riau	1.666	10.770	12.436	13,40	86,60
12	J a m b i	6.737	20.396	27.133	24,83	75,17
13	Sumatera Selatan	12.427	45.939	58.366	21,29	78,71
14	Bangka Belitung	1.636	6.894	8.530	19,18	80,82
15	Bengkulu	2.762	12.096	14.858	18,59	81,41
16	Lampung	11.253	43.651	54.904	20,50	79,50
17	Kalimantan Barat	10.821	27.733	38.554	28,07	71,93
18	Kalimantan Tengah	4.781	19.419	24.200	19,76	80,24
19	Kalimantan Selatan	4.245	25.670	29.915	14,19	85,81
20	Kalimantan Timur	4.115	20.332	24.447	16,83	83,17
21	Kalimantan Utara	1.543	4.002	5.545	27,83	72,17
22	Sulawesi Utara	4.842	13.372	18.214	26,58	73,42
23	Gorontalo	1.279	7.064	8.343	15,33	84,67
24	Sulawesi Tengah	8.963	17.808	26.771	33,48	66,52
25	Sulawesi Selatan	9.254	60.743	69.997	13,22	86,78
26	Sulawesi Barat	4.311	8.660	12.971	33,24	66,76
27	Sulawesi Tenggara	5.235	18.289	23.524	22,25	77,75
28	M a l u k u	6.352	10.423	16.775	37,87	62,13
29	Maluku Utara	4.846	4.994	9.840	49,25	50,75
30	B a l i	1.957	23.652	25.609	7,64	92,36
31	Nusa Tenggara Barat	6.968	32.385	39.353	17,71	82,29
32	Nusa Tenggara Timur	16.947	34.597	51.544	32,88	67,12
33	Papua	6.808	8.300	15.108	45,06	54,94
34	Papua Barat	1.909	4.923	6.832	27,94	72,06
	<b>Indonesia</b>	<b>250.453</b>	<b>1.335.674</b>	<b>1.586.127</b>	<b>15,79</b>	<b>84,21</b>



**Tabel : 21**  
**Jumlah Kepala Sekolah + Guru Sekolah Menengah Pertama**  
**Menurut Ijazah Tertinggi Tiap Provinsi**  
**Tahun 2016/2017**

No.	Provinsi	< S1	> S1	JUMLAH	PERSENTASE	
					< S1	> = S1
(1)	(2)	(3)	(4)	(5)	(6)	(7)
1	DKI Jakarta	910	16.580	17.490	5,20	94,80
2	Jawa Barat	5.328	76.275	81.603	6,53	93,47
3	Banten	1.339	18.515	19.854	6,74	93,26
4	Jawa Tengah	3.634	67.231	70.865	5,13	94,87
5	DI Yogyakarta	698	8.127	8.825	7,91	92,09
6	Jawa Timur	3.514	75.853	79.367	4,43	95,57
7	Aceh	1.980	19.540	21.520	9,20	90,80
8	Sumatera Utara	3.995	35.970	39.965	10,00	90,00
9	Sumatera Barat	1.660	15.670	17.330	9,58	90,42
10	R i a u	1.867	16.021	17.888	10,44	89,56
11	Kep. Riau	395	4.224	4.619	8,55	91,45
12	J a m b i	814	9.139	9.953	8,18	91,82
13	Sumatera Selatan	2.128	20.966	23.094	9,21	90,79
14	Bangka Belitung	285	2.685	2.970	9,60	90,40
15	Bengkulu	493	6.125	6.618	7,45	92,55
16	Lampung	2.637	18.118	20.755	12,71	87,29
17	Kalimantan Barat	1.923	11.746	13.669	14,07	85,93
18	Kalimantan Tengah	660	7.711	8.371	7,88	92,12
19	Kalimantan Selatan	485	8.535	9.020	5,38	94,62
20	Kalimantan Timur	614	8.883	9.497	6,47	93,53
21	Kalimantan Utara	148	2.024	2.172	6,81	93,19
22	Sulawesi Utara	1.304	7.171	8.475	15,39	84,61
23	Gorontalo	331	3.488	3.819	8,67	91,33
24	Sulawesi Tengah	823	8.791	9.614	8,56	91,44
25	Sulawesi Selatan	1.452	26.388	27.840	5,22	94,78
26	Sulawesi Barat	553	3.834	4.387	12,61	87,39
27	Sulawesi Tenggara	738	9.350	10.088	7,32	92,68
28	M a l u k u	1.766	5.882	7.648	23,09	76,91
29	Maluku Utara	710	3.974	4.684	15,16	84,84
30	B a l i	600	10.913	11.513	5,21	94,79
31	Nusa Tenggara Barat	926	15.864	16.790	5,52	94,48
32	Nusa Tenggara Timur	3.167	19.363	22.530	14,06	85,94
33	Papua	1.058	5.706	6.764	15,64	84,36
34	Papua Barat	212	2.972	3.184	6,66	93,34
	<b>Indonesia</b>	<b>49.147</b>	<b>573.634</b>	<b>622.781</b>	<b>7,89</b>	<b>92,11</b>



**Tabel : 22**  
**Jumlah Kepala Sekolah + Guru Sekolah Menengah Atas**  
**Menurut Ijazah Tertinggi Tiap Provinsi**  
**Tahun 2016/2017**

No.	Provinsi	< S1	> S1	JUMLAH	PERSENTASE	
					< S1	> = S1
(1)	(2)	(3)	(4)	(5)	(6)	(7)
1	DKI Jakarta	210	9.744	9.954	2,11	97,89
2	Jawa Barat	1.017	30.889	31.906	3,19	96,81
3	Banten	303	8.636	8.939	3,39	96,61
4	Jawa Tengah	668	24.209	24.877	2,69	97,31
5	DI Yogyakarta	120	4.059	4.179	2,87	97,13
6	Jawa Timur	779	31.232	32.011	2,43	97,57
7	Aceh	404	13.480	13.884	2,91	97,09
8	Sumatera Utara	964	19.440	20.404	4,72	95,28
9	Sumatera Barat	320	10.865	11.185	2,86	97,14
10	R i a u	370	9.822	10.192	3,63	96,37
11	Kep. Riau	65	2.290	2.355	2,76	97,24
12	J a m b i	123	5.162	5.285	2,33	97,67
13	Sumatera Selatan	436	12.785	13.221	3,30	96,70
14	Bangka Belitung	79	1.376	1.455	5,43	94,57
15	Bengkulu	79	3.491	3.570	2,21	97,79
16	Lampung	422	9.274	9.696	4,35	95,65
17	Kalimantan Barat	324	5.810	6.134	5,28	94,72
18	Kalimantan Tengah	139	4.049	4.188	3,32	96,68
19	Kalimantan Selatan	95	4.135	4.230	2,25	97,75
20	Kalimantan Timur	133	4.129	4.262	3,12	96,88
21	Kalimantan Utara	35	1.065	1.100	3,18	96,82
22	Sulawesi Utara	130	3.907	4.037	3,22	96,78
23	Gorontalo	27	1.604	1.631	1,66	98,34
24	Sulawesi Tengah	162	4.129	4.291	3,78	96,22
25	Sulawesi Selatan	261	14.021	14.282	1,83	98,17
26	Sulawesi Barat	59	1.643	1.702	3,47	96,53
27	Sulawesi Tenggara	153	6.230	6.383	2,40	97,60
28	M a l u k u	271	5.097	5.368	5,05	94,95
29	Maluku Utara	129	2.670	2.799	4,61	95,39
30	B a l i	125	5.437	5.562	2,25	97,75
31	Nusa Tenggara Barat	170	8.368	8.538	1,99	98,01
32	Nusa Tenggara Timur	439	11.202	11.641	3,77	96,23
33	Papua	138	3.536	3.674	3,76	96,24
34	Papua Barat	53	1.884	1.937	2,74	97,26
<b>Indonesia</b>		<b>9.202</b>	<b>285.670</b>	<b>294.872</b>	<b>3,12</b>	<b>96,88</b>



**Tabel : 23**  
**Jumlah Kepala Sekolah + Guru Sekolah Menengah Kejuruan**  
**Menurut Ijazah Tertinggi Tiap Provinsi**  
**Tahun 2016/2017**

No.	Provinsi	< S1	> S1	JUMLAH	PERSENTASE	
					< S1	> = S1
(1)	(2)	(3)	(4)	(5)	(6)	(7)
1	DKI Jakarta	439	9.469	9.908	4,43	95,57
2	Jawa Barat	3.180	39.804	42.984	7,40	92,60
3	Banten	704	9.022	9.726	7,24	92,76
4	Jawa Tengah	2.095	40.720	42.815	4,89	95,11
5	DI Yogyakarta	320	6.441	6.761	4,73	95,27
6	Jawa Timur	1.906	38.951	40.857	4,67	95,33
7	Aceh	276	5.377	5.653	4,88	95,12
8	Sumatera Utara	1.277	15.841	17.118	7,46	92,54
9	Sumatera Barat	230	7.037	7.267	3,16	96,84
10	R i a u	426	6.191	6.617	6,44	93,56
11	Kep. Riau	133	1.706	1.839	7,23	92,77
12	J a m b i	190	3.444	3.634	5,23	94,77
13	Sumatera Selatan	490	5.964	6.454	7,59	92,41
14	Bangka Belitung	124	1.320	1.444	8,59	91,41
15	Bengkulu	148	2.143	2.291	6,46	93,54
16	Lampung	805	7.115	7.920	10,16	89,84
17	Kalimantan Barat	263	3.032	3.295	7,98	92,02
18	Kalimantan Tengah	118	2.404	2.522	4,68	95,32
19	Kalimantan Selatan	176	3.245	3.421	5,14	94,86
20	Kalimantan Timur	329	4.341	4.670	7,04	92,96
21	Kalimantan Utara	27	686	713	3,79	96,21
22	Sulawesi Utara	202	3.339	3.541	5,70	94,30
23	Gorontalo	101	1.493	1.594	6,34	93,66
24	Sulawesi Tengah	212	3.034	3.246	6,53	93,47
25	Sulawesi Selatan	401	9.417	9.818	4,08	95,92
26	Sulawesi Barat	170	1.766	1.936	8,78	91,22
27	Sulawesi Tenggara	153	2.890	3.043	5,03	94,97
28	M a l u k u	243	2.005	2.248	10,81	89,19
29	Maluku Utara	156	1.445	1.601	9,74	90,26
30	B a l i	298	4.999	5.297	5,63	94,37
31	Nusa Tenggara Barat	303	6.166	6.469	4,68	95,32
32	Nusa Tenggara Timur	543	5.448	5.991	9,06	90,94
33	Papua	185	2.249	2.434	7,60	92,40
34	Papua Barat	63	909	972	6,48	93,52
<b>Indonesia</b>		<b>16.686</b>	<b>259.413</b>	<b>276.099</b>	<b>6,04</b>	<b>93,96</b>

**Grafik : 9**  
Persentase Kepala Sekolah + Guru Menurut Ijazah Tertinggi  
Semua Jenjang Pendidikan  
Tahun 2016/2017

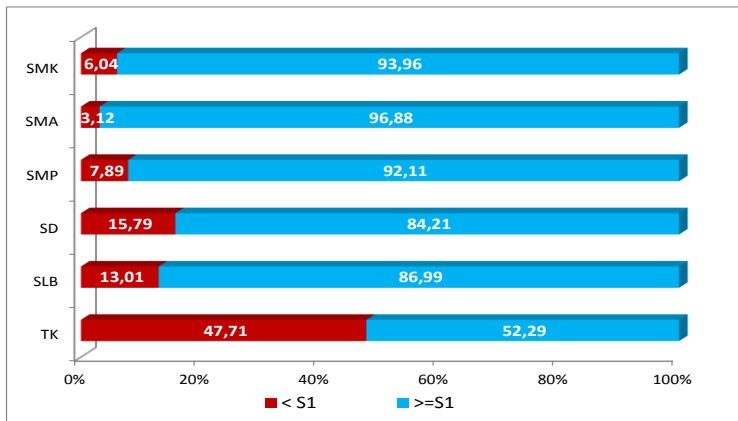

**Grafik : 10**  
Persentase Kepala Sekolah + Guru Menurut Status Kepegawaian  
Semua Jenjang Pendidikan  
Tahun 2016/2017

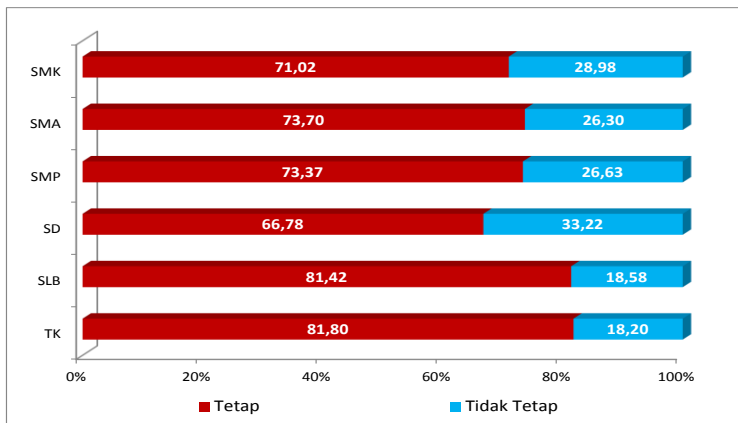



**Tabel : 24**  
**Jumlah Rombongan Belajar Jenjang Pendidikan Sekolah Dasar**  
**Tahun 2016/2017**

No.	Provinsi	I	II	III	IV	V	VI	Jumlah
(1)	(2)	(3)	(4)	(5)	(6)	(7)	(8)	(9)
1	DKI Jakarta	4.577	4.726	4.959	4.966	4.749	4.550	28.527
2	Jawa Barat	27.060	26.941	26.813	26.920	26.332	25.807	159.873
3	Banten	7.111	7.139	7.018	6.915	6.652	6.506	41.341
4	Jawa Tengah	21.517	21.439	21.303	21.336	21.021	20.810	127.426
5	DI Yogyakarta	2.264	2.284	2.279	2.259	2.226	2.225	13.537
6	Jawa Timur	22.583	22.529	22.508	22.586	22.228	22.202	134.636
7	Aceh	4.082	4.086	4.088	4.024	3.931	3.783	23.994
8	Sumatera Utara	12.425	12.380	12.335	12.175	11.931	11.696	72.942
9	Sumatera Barat	5.136	5.130	5.058	5.065	4.980	4.828	30.197
10	Riau	5.801	5.816	5.697	5.503	5.351	5.224	33.392
11	Kep. Riau	1.573	1.582	1.558	1.496	1.455	1.390	9.054
12	Jambi	3.152	3.138	3.135	3.083	3.016	2.967	18.491
13	Sumatera Selatan	6.778	6.752	6.678	6.467	6.277	6.107	39.059
14	Bangka Belitung	1.099	1.098	1.081	1.068	1.035	1.023	6.404
15	Bengkulu	1.781	1.788	1.760	1.732	1.719	1.709	10.489
16	Lampung	6.367	6.294	6.197	6.086	5.932	5.871	36.747
17	Kalimantan Barat	5.266	5.225	5.200	5.039	4.940	4.865	30.535
18	Kalimantan Tengah	2.904	2.934	2.895	2.864	2.822	2.775	17.194
19	Kalimantan Selatan	3.524	3.467	3.436	3.374	3.332	3.285	20.418
20	Kalimantan Timur	2.945	2.955	2.930	2.878	2.767	2.708	17.183
21	Kalimantan Utara	668	670	638	637	611	601	3.825
22	Sulawesi Utara	2.363	2.396	2.413	2.417	2.383	2.351	14.323
23	Gorontalo	1.028	1.027	1.050	1.047	1.030	1.015	6.197
24	Sulawesi Tengah	3.124	3.139	3.172	3.154	3.105	3.087	18.781
25	Sulawesi Selatan	7.619	7.590	7.608	7.671	7.532	7.438	45.458
26	Sulawesi Barat	1.473	1.503	1.491	1.494	1.456	1.449	8.866
27	Sulawesi Tenggara	2.692	2.712	2.766	2.754	2.717	2.669	16.310
28	Maluku	1.941	1.915	1.953	1.942	1.921	1.877	11.549
29	Maluku Utara	1.306	1.336	1.335	1.326	1.302	1.295	7.900
30	Bali	2.882	2.849	2.838	2.857	2.801	2.784	17.011
31	Nusa Tenggara Barat	3.751	3.721	3.700	3.699	3.633	3.558	22.062
32	Nusa Tenggara Timur	6.199	6.187	6.286	6.313	6.106	5.848	36.939
33	Papua	2.808	2.787	2.709	2.622	2.525	2.416	15.867
34	Papua Barat	1.128	1.150	1.137	1.128	1.091	1.071	6.705
	<b>Indonesia</b>	<b>186.927</b>	<b>186.685</b>	<b>186.024</b>	<b>184.897</b>	<b>180.909</b>	<b>177.790</b>	<b>1.103.232</b>





**Tabel : 25**  
**Jumlah Rombongan Belajar Jenjang Pendidikan Sekolah Menengah Pertama**  
**Menurut Tingkat Tiap Provinsi**  
**Tahun 2016/2017**

No.	Provinsi	VII	VIII	IX	Jumlah
(1)	(2)	(3)	(4)	(5)	(6)
1	DKI Jakarta	3.934	4.071	4.005	12.010
2	Jawa Barat	18.553	18.474	17.713	54.740
3	Banten	4.497	4.476	4.291	13.264
4	Jawa Tengah	13.504	13.513	13.436	40.453
5	DI Yogyakarta	1.509	1.520	1.535	4.564
6	Jawa Timur	14.778	14.831	14.503	44.112
7	Aceh	2.673	2.715	2.667	8.055
8	Sumatera Utara	7.424	7.267	7.004	21.695
9	Sumatera Barat	2.764	2.724	2.623	8.111
10	R i a u	3.179	3.094	2.977	9.250
11	Kep. Riau	946	916	883	2.745
12	J a m b i	1.639	1.625	1.586	4.850
13	Sumatera Selatan	3.982	3.853	3.692	11.527
14	Bangka Belitung	664	654	612	1.930
15	Bengkulu	1.171	1.142	1.117	3.430
16	Lampung	3.757	3.703	3.627	11.087
17	Kalimantan Barat	2.822	2.776	2.612	8.210
18	Kalimantan Tengah	1.497	1.492	1.431	4.420
19	Kalimantan Selatan	1.566	1.564	1.499	4.629
20	Kalimantan Timur	1.831	1.810	1.743	5.384
21	Kalimantan Utara	396	386	364	1.146
22	Sulawesi Utara	1.626	1.652	1.562	4.840
23	Gorontalo	728	713	662	2.103
24	Sulawesi Tengah	1.836	1.814	1.717	5.367
25	Sulawesi Selatan	4.971	4.955	4.854	14.780
26	Sulawesi Barat	811	809	776	2.396
27	Sulawesi Tenggara	1.830	1.818	1.737	5.385
28	M a l u k u	1.325	1.338	1.316	3.979
29	Maluku Utara	831	839	808	2.478
30	B a l i	2.066	2.079	2.049	6.194
31	Nusa Tenggara Barat	2.321	2.335	2.280	6.936
32	Nusa Tenggara Timur	4.274	4.030	3.841	12.145
33	Papua	1.418	1.418	1.334	4.170
34	Papua Barat	635	601	553	1.789
<b>Indonesia</b>		<b>117.758</b>	<b>117.007</b>	<b>113.409</b>	<b>348.174</b>



**Tabel : 26**  
**Jumlah Rombongan Belajar Jenjang Pendidikan Sekolah Menengah Atas**  
**Menurut Tingkat Tiap Provinsi**  
**Tahun 2016/2017**

No.	Provinsi	X	XI	XII	Jumlah
(1)	(2)	(3)	(4)	(5)	(6)
1	DKI Jakarta	1.878	1.912	1.744	5.534
2	Jawa Barat	6.913	6.594	5.950	19.457
3	Banten	1.903	1.919	1.759	5.581
4	Jawa Tengah	4.424	4.345	4.161	12.930
5	DI Yogyakarta	672	704	670	2.046
6	Jawa Timur	5.947	5.952	5.544	17.443
7	Aceh	1.848	1.809	1.720	5.377
8	Sumatera Utara	3.781	3.786	3.531	11.098
9	Sumatera Barat	1.699	1.662	1.594	4.955
10	R i a u	1.699	1.683	1.574	4.956
11	Kep. Riau	444	444	407	1.295
12	J a m b i	847	873	820	2.540
13	Sumatera Selatan	2.189	2.168	2.037	6.394
14	Bangka Belitung	292	277	255	824
15	Bengkulu	600	589	541	1.730
16	Lampung	1.745	1.703	1.576	5.024
17	Kalimantan Barat	1.301	1.265	1.161	3.727
18	Kalimantan Tengah	717	706	663	2.086
19	Kalimantan Selatan	774	751	692	2.217
20	Kalimantan Timur	824	811	740	2.375
21	Kalimantan Utara	187	188	182	557
22	Sulawesi Utara	729	780	740	2.249
23	Gorontalo	332	321	285	938
24	Sulawesi Tengah	847	818	747	2.412
25	Sulawesi Selatan	2.600	2.618	2.469	7.687
26	Sulawesi Barat	313	308	276	897
27	Sulawesi Tenggara	1.142	1.115	1.070	3.327
28	M a l u k u	869	917	864	2.650
29	Maluku Utara	458	481	462	1.401
30	B a l i	905	931	859	2.695
31	Nusa Tenggara Barat	1.159	1.171	1.139	3.469
32	Nusa Tenggara Timur	2.099	2.104	2.019	6.222
33	Papua	685	689	661	2.035
34	Papua Barat	348	355	331	1.034
<b>Indonesia</b>		<b>53.170</b>	<b>52.749</b>	<b>49.243</b>	<b>155.162</b>



**Tabel : 27**  
**Jumlah Rombongan Belajar Jenjang Pendidikan Sekolah Menengah Kejuruan**  
**Menurut Tingkat Tiap Provinsi**  
**Tahun 2016/2017**

No.	Provinsi	X	XI	XII	XIII	Jumlah
(1)	(2)	(3)	(4)	(5)	(6)	(7)
1	DKI Jakarta	2.429	2.394	2.241	14	7.078
2	Jawa Barat	11.683	11.094	9.556	41	32.374
3	Banten	2.717	2.671	2.349	3	7.740
4	Jawa Tengah	8.777	8.531	7.649	45	25.002
5	DI Yogyakarta	1.149	1.108	1.047	-	3.304
6	Jawa Timur	8.544	8.175	7.300	18	24.037
7	Aceh	833	763	676	-	2.272
8	Sumatera Utara	3.625	3.474	3.204	-	10.303
9	Sumatera Barat	1.163	1.084	972	6	3.225
10	R i a u	1.228	1.180	1.070	1	3.479
11	Kep. Riau	386	388	363	-	1.137
12	J a m b i	654	619	563	-	1.836
13	Sumatera Selatan	1.284	1.208	1.049	-	3.541
14	Bangka Belitung	282	277	242	-	801
15	Bengkulu	402	376	348	-	1.126
16	Lampung	1.666	1.598	1.406	-	4.670
17	Kalimantan Barat	758	700	610	-	2.068
18	Kalimantan Tengah	459	436	387	-	1.282
19	Kalimantan Selatan	648	622	557	-	1.827
20	Kalimantan Timur	937	927	853	-	2.717
21	Kalimantan Utara	117	115	101	-	333
22	Sulawesi Utara	805	787	713	-	2.305
23	Gorontalo	287	284	260	-	831
24	Sulawesi Tengah	683	632	563	-	1.878
25	Sulawesi Selatan	1.858	1.819	1.700	5	5.382
26	Sulawesi Barat	371	364	331	-	1.066
27	Sulawesi Tenggara	538	514	460	-	1.512
28	M a l u k u	382	344	306	-	1.032
29	Maluku Utara	293	287	259	-	839
30	B a l i	1.053	996	895	1	2.945
31	Nusa Tenggara Barat	947	880	804	-	2.631
32	Nusa Tenggara Timur	1.097	1.008	836	-	2.941
33	Papua	478	440	391	-	1.309
34	Papua Barat	203	191	169	-	563
<b>Indonesia</b>		<b>58.736</b>	<b>56.286</b>	<b>50.230</b>	<b>134</b>	<b>165.386</b>



**Tabel : 28**  
**Jumlah Ruang Kelas Menurut Kondisi dan Jenjang Pendidikan**  
**Semua Jenjang Pendidikan**  
**Tahun 2016/2017**

No.	Jenjang Pendidikan	Baik	%	Rusak Ringan	%	Rusak Sedang	%	Rusak Berat	%	Rusak Total	%	Jumlah
(1)	(2)	(3)	(4)	(5)	(6)	(5)	(6)	(5)	(6)	(7)	(8)	(9)
1	SD	270.028	25,74	601.393	57,32	69.551	6,63	58.269	5,55	49.875	4,75	1.049.116
2.	SLB	7.017	35,57	11.032	55,92	718	3,64	524	2,66	436	2,21	19.727
3.	SMP	99.853	28,73	195.791	56,33	21.683	6,24	17.057	4,91	13.208	3,80	347.592
4.	SM	134.522	45,66	140.344	47,64	8.058	2,74	5.726	1,94	5.966	2,03	294.616
	a. SMA	69.147	45,66	70.773	46,73	4.943	3,26	3.224	2,13	3.354	2,21	151.441
	b. SMK	65.375	45,66	69.571	48,59	3.115	2,18	2.502	1,75	2.612	1,82	143.175

**Grafik : 11**  
**Persentase Ruang Kelas Menurut Kondisi**  
**Semua Jenjang Pendidikan**  
**Tahun 2016/2017**

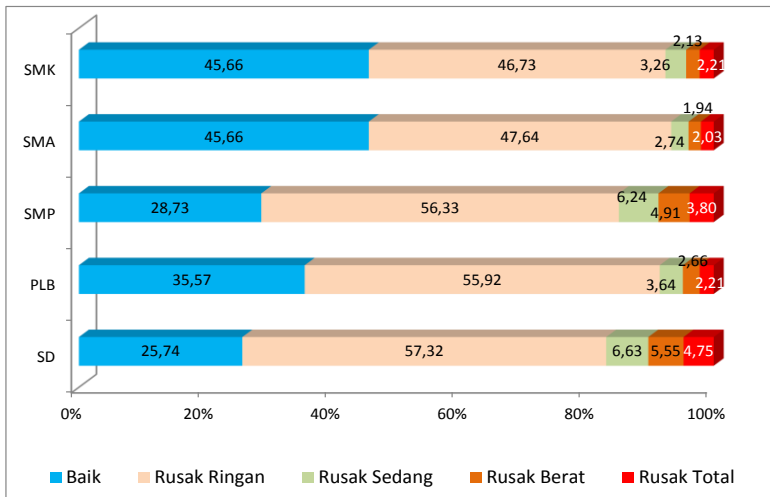



**Tabel : 29**  
**Jumlah Ruang Kelas Sekolah Dasar**  
**Menurut Kondisi Tiap Provinsi**  
**Tahun 2016/2017**

No.	Provinsi	Baik	Rusak Ringan	Rusak Sedang	Rusak Berat	Rusak Total	Jumlah
(1)	(2)	(3)	(4)	(5)	(6)	(7)	(8)
1	DKI Jakarta	15.174	9.030	550	313	510	25.577
2	Jawa Barat	28.017	82.392	11.250	9.533	7.060	138.252
3	Banten	11.343	19.530	1.726	1.785	1.450	35.834
4	Jawa Tengah	28.667	80.562	7.691	6.141	4.609	127.670
5	DI Yogyakarta	4.141	8.979	415	211	147	13.893
6	Jawa Timur	31.732	81.098	8.281	6.699	6.069	133.879
7	Aceh	5.876	14.187	1.622	1.520	941	24.146
8	Sumatera Utara	21.848	38.869	3.946	2.901	2.670	70.234
9	Sumatera Barat	8.863	17.773	1.501	1.002	792	29.931
10	R i a u	8.859	17.275	1.853	1.421	1.052	30.460
11	Kep. Riau	2.894	4.125	311	173	148	7.651
12	J a m b i	3.660	10.724	1.508	934	769	17.595
13	Sumatera Selatan	9.282	19.918	1.930	1.613	1.474	34.217
14	Bangka Belitung	2.660	3.547	219	146	71	6.643
15	Bengkulu	2.326	6.355	704	568	339	10.292
16	Lampung	6.669	19.442	2.971	2.650	2.490	34.222
17	Kalimantan Barat	5.917	15.950	2.630	2.168	1.686	28.351
18	Kalimantan Tengah	3.995	10.428	1.154	698	585	16.860
19	Kalimantan Selatan	5.844	12.066	1.006	854	685	20.455
20	Kalimantan Timur	5.684	8.296	737	429	332	15.478
21	Kalimantan Utara	999	2.008	142	175	147	3.471
22	Sulawesi Utara	5.058	7.088	782	668	920	14.516
23	Gorontalo	2.193	3.254	403	317	243	6.410
24	Sulawesi Tengah	5.426	9.068	1.457	1.482	1.408	18.841
25	Sulawesi Selatan	11.208	24.919	2.942	2.576	2.320	43.965
26	Sulawesi Barat	1.752	4.323	805	877	833	8.590
27	Sulawesi Tenggara	3.697	7.722	1.360	1.580	1.262	15.621
28	M a l u k u	2.978	6.181	815	682	629	11.285
29	Maluku Utara	1.430	4.214	754	713	590	7.701
30	B a l i	6.091	9.496	489	299	294	16.669
31	Nusa Tenggara Barat	4.925	11.845	1.591	1.494	1.115	20.970
32	Nusa Tenggara Timur	6.295	19.356	4.191	3.945	4.449	38.236
33	Papua	3.388	8.060	1.264	1.292	1.067	15.071
34	Papua Barat	1.137	3.313	551	410	719	6.130
	<b>Indonesia</b>	<b>270.028</b>	<b>601.393</b>	<b>69.551</b>	<b>58.269</b>	<b>49.875</b>	<b>1.049.116</b>



**Tabel : 30**  
**Jumlah Ruang Kelas Sekolah Luar Biasa**  
**Menurut Kondisi Tiap Provinsi**  
**Tahun 2016/2017**

No.	Provinsi	Baik	Rusak Ringan	Rusak Sedang	Rusak Berat	Rusak Total	Jumlah
(1)	(2)	(3)	(4)	(5)	(6)	(7)	(8)
1	DKI Jakarta	725	493	15	6	25	1.264
2	Jawa Barat	700	1.928	151	123	88	2.990
3	Banten	260	399	30	16	7	712
4	Jawa Tengah	762	1.680	83	58	2	2.585
5	DI Yogyakarta	662	477	24	30	1	1.194
6	Jawa Timur	857	1.710	128	96	87	2.878
7	Aceh	152	210	10	7	44	423
8	Sumatera Utara	197	298	11	1	-	507
9	Sumatera Barat	407	547	17	19	17	1.007
10	R i a u	143	228	9	6	-	386
11	Kep. Riau	88	67	-	-	-	155
12	J a m b i	81	116	18	-	-	215
13	Sumatera Selatan	197	132	3	13	-	345
14	Bangka Belitung	94	40	-	-	3	137
15	Bengkulu	46	125	4	21	-	196
16	Lampung	97	202	1	-	2	302
17	Kalimantan Barat	57	122	6	1	-	186
18	Kalimantan Tengah	68	105	-	-	-	173
19	Kalimantan Selatan	133	289	30	9	-	461
20	Kalimantan Timur	165	122	15	17	5	324
21	Kalimantan Utara	16	27	-	-	-	43
22	Sulawesi Utara	116	122	2	-	2	242
23	Gorontalo	10	94	2	-	-	106
24	Sulawesi Tengah	112	98	-	8	2	220
25	Sulawesi Selatan	249	478	43	22	59	851
26	Sulawesi Barat	19	78	8	2	7	114
27	Sulawesi Tenggara	105	82	42	29	30	288
28	M a l u k u	43	21	3	-	-	67
29	Maluku Utara	84	84	8	1	6	183
30	B a l i	72	157	-	-	5	234
31	Nusa Tenggara Barat	114	288	15	10	16	443
32	Nusa Tenggara Timur	151	135	30	29	28	373
33	Papua	34	60	10	-	-	104
34	Papua Barat	1	18	-	-	-	19
	<b>Indonesia</b>	<b>7.017</b>	<b>11.032</b>	<b>718</b>	<b>524</b>	<b>436</b>	<b>19.727</b>



**Tabel : 31**  
**Jumlah Ruang Kelas Sekolah Menengah Pertama**  
**Menurut Kondisi Tiap Provinsi**  
**Tahun 2016/2017**

No.	Provinsi	Baik	Rusak Ringan	Rusak Sedang	Rusak Berat	Rusak Total	Jumlah
(1)	(2)	(3)	(4)	(5)	(6)	(7)	(8)
1	DKI Jakarta	6.872	4.051	349	177	243	11.692
2	Jawa Barat	13.764	30.130	3.867	2.560	1.968	52.289
3	Banten	4.885	6.824	690	562	444	13.405
4	Jawa Tengah	11.163	24.853	2.219	1.567	1.167	40.969
5	DI Yogyakarta	1.567	2.979	106	101	36	4.789
6	Jawa Timur	11.585	26.398	2.345	1.903	1.308	43.539
7	Aceh	2.012	5.137	771	676	385	8.981
8	Sumatera Utara	7.082	12.326	1.019	1.039	853	22.319
9	Sumatera Barat	2.539	4.741	502	376	340	8.498
10	R i a u	2.634	5.369	619	381	226	9.229
11	Kep. Riau	1.116	1.316	138	81	67	2.718
12	J a m b i	1.177	3.028	408	289	175	5.077
13	Sumatera Selatan	2.781	6.237	858	746	642	11.264
14	Bangka Belitung	905	989	64	61	19	2.038
15	Bengkulu	791	2.061	260	261	186	3.559
16	Lampung	2.454	6.522	983	887	593	11.439
17	Kalimantan Barat	2.084	4.872	618	442	379	8.395
18	Kalimantan Tengah	1.200	2.902	259	177	166	4.704
19	Kalimantan Selatan	1.420	3.031	190	149	115	4.905
20	Kalimantan Timur	2.075	2.908	183	121	67	5.354
21	Kalimantan Utara	384	535	76	39	22	1.056
22	Sulawesi Utara	1.387	2.781	289	305	174	4.936
23	Gorontalo	758	1.051	98	112	111	2.130
24	Sulawesi Tengah	1.422	2.876	462	406	383	5.549
25	Sulawesi Selatan	3.973	8.768	940	618	513	14.812
26	Sulawesi Barat	672	1.240	217	136	189	2.454
27	Sulawesi Tenggara	1.397	2.799	433	529	389	5.547
28	M a l u k u	934	2.090	315	300	328	3.967
29	Maluku Utara	525	1.163	284	209	165	2.346
30	B a l i	2.515	2.544	120	99	35	5.313
31	Nusa Tenggara Barat	1.793	3.719	549	491	311	6.863
32	Nusa Tenggara Timur	2.651	6.069	1.035	911	889	11.555
33	Papua	986	2.392	302	232	209	4.121
34	Papua Barat	350	1.090	115	114	111	1.780
	<b>Indonesia</b>	<b>99.853</b>	<b>195.791</b>	<b>21.683</b>	<b>17.057</b>	<b>13.208</b>	<b>347.592</b>



**Tabel : 32**  
**Jumlah Ruang Kelas Sekolah Menengah Atas**  
**Menurut Kondisi Tiap Provinsi**  
**Tahun 2016/2017**

No.	Provinsi	Baik	Rusak Ringan	Rusak Sedang	Rusak Berat	Rusak Total	Jumlah
(1)	(2)	(3)	(4)	(5)	(6)	(7)	(8)
1	DKI Jakarta	3.528	1.984	9	11	95	5.627
2	Jawa Barat	8.590	8.502	566	401	456	18.515
3	Banten	2.668	2.316	212	122	87	5.405
4	Jawa Tengah	7.055	5.519	275	196	154	13.199
5	DI Yogyakarta	1.031	978	52	16	32	2.109
6	Jawa Timur	7.825	7.754	480	234	346	16.639
7	Aceh	1.785	3.306	282	155	93	5.621
8	Sumatera Utara	5.316	5.100	294	232	228	11.170
9	Sumatera Barat	2.522	2.009	173	108	68	4.880
10	R i a u	2.312	2.216	179	111	87	4.905
11	Kep. Riau	646	575	22	22	27	1.292
12	J a m b i	909	1.332	96	87	39	2.463
13	Sumatera Selatan	2.830	3.013	245	140	140	6.368
14	Bangka Belitung	514	311	11	19	2	857
15	Bengkulu	603	1.002	32	37	56	1.730
16	Lampung	1.927	2.560	220	144	88	4.939
17	Kalimantan Barat	1.695	1.614	123	93	96	3.621
18	Kalimantan Tengah	842	1.074	64	42	34	2.056
19	Kalimantan Selatan	1.198	938	24	20	20	2.200
20	Kalimantan Timur	1.256	898	18	10	66	2.248
21	Kalimantan Utara	173	316	12	4	1	506
22	Sulawesi Utara	979	1.057	113	56	31	2.236
23	Gorontalo	489	411	9	6	10	925
24	Sulawesi Tengah	951	1.100	112	78	68	2.309
25	Sulawesi Selatan	3.396	3.575	248	126	131	7.476
26	Sulawesi Barat	429	385	23	18	31	886
27	Sulawesi Tenggara	1.330	1.370	180	188	119	3.187
28	M a l u k u	702	1.322	184	92	128	2.428
29	Maluku Utara	437	683	104	62	56	1.342
30	B a l i	1.402	1.093	9	1	29	2.534
31	Nusa Tenggara Barat	1.164	1.854	129	74	112	3.333
32	Nusa Tenggara Timur	1.682	2.865	341	242	352	5.482
33	Papua	633	1.157	78	43	45	1.956
34	Papua Barat	328	584	24	34	27	997
	<b>Indonesia</b>	<b>69.147</b>	<b>70.773</b>	<b>4.943</b>	<b>3.224</b>	<b>3.354</b>	<b>151.441</b>





**Tabel : 33**  
**Jumlah Ruang Kelas Sekolah Menengah Kejuruan**  
**Menurut Kondisi Tiap Provinsi**  
**Tahun 2016/2017**

No.	Provinsi	Baik	Rusak Ringan	Rusak Sedang	Rusak Berat	Rusak Total	Jumlah
(1)	(2)	(3)	(4)	(5)	(6)	(7)	(8)
1	DKI Jakarta	2.984	3.088	66	56	86	6.280
2	Jawa Barat	12.079	12.875	683	629	629	26.895
3	Banten	2.644	3.346	203	83	200	6.476
4	Jawa Tengah	9.349	11.015	312	319	322	21.317
5	DI Yogyakarta	1.648	1.147	20	14	44	2.873
6	Jawa Timur	8.241	9.854	491	399	349	19.334
7	Aceh	943	1.129	25	23	13	2.133
8	Sumatera Utara	4.892	4.412	271	211	153	9.939
9	Sumatera Barat	1.486	1.108	53	3	17	2.667
10	R i a u	1.523	1.439	83	81	67	3.193
11	Kep. Riau	452	573	8	1	3	1.037
12	J a m b i	683	984	38	39	62	1.806
13	Sumatera Selatan	1.430	1.428	61	56	52	3.027
14	Bangka Belitung	444	344	11	6	17	822
15	Bengkulu	439	616	36	3	4	1.098
16	Lampung	1.665	2.260	112	66	67	4.170
17	Kalimantan Barat	976	820	44	32	33	1.905
18	Kalimantan Tengah	566	702	10	7	20	1.305
19	Kalimantan Selatan	703	890	4	47	17	1.661
20	Kalimantan Timur	1.186	1.172	9	19	13	2.399
21	Kalimantan Utara	139	122	20	1	1	283
22	Sulawesi Utara	945	1.135	14	27	30	2.151
23	Gorontalo	471	286	38	10	7	812
24	Sulawesi Tengah	745	919	32	40	21	1.757
25	Sulawesi Selatan	2.777	1.924	95	48	85	4.929
26	Sulawesi Barat	457	436	24	53	20	990
27	Sulawesi Tenggara	569	713	51	40	24	1.397
28	M a l u k u	422	410	32	16	20	900
29	Maluku Utara	321	387	2	13	15	738
30	B a l i	1.202	1.039	6	3	7	2.257
31	Nusa Tenggara Barat	1.074	1.022	65	47	50	2.258
32	Nusa Tenggara Timur	1.124	1.125	135	84	119	2.587
33	Papua	555	591	46	21	16	1.229
34	Papua Barat	241	260	15	5	29	550
	<b>Indonesia</b>	<b>65.375</b>	<b>69.571</b>	<b>3.115</b>	<b>2.502</b>	<b>2.612</b>	<b>143.175</b>



**Tabel : 34**  
**Angka Melanjutkan SD ke SMP Tiap Provinsi**  
**Tahun 2016/2017**

No.	Provinsi	LULUSAN SD	SISWA BARU SMP	AM %
(1)	(2)	(3)	(4)	(5)
1	DKI Jakarta	139.116	121.723	87,50
2	Jawa Barat	799.818	607.099	75,90
3	Banten	204.852	143.924	70,26
4	Jawa Tengah	510.899	408.918	80,04
5	DI Yogyakarta	50.178	43.083	85,86
6	Jawa Timur	525.608	427.311	81,30
7	Aceh	79.779	63.877	80,07
8	Sumatera Utara	297.318	227.480	76,51
9	Sumatera Barat	107.866	74.835	69,38
10	R i a u	130.025	90.056	69,26
11	Kep. Riau	34.858	29.736	85,31
12	J a m b i	66.408	42.782	64,42
13	Sumatera Selatan	153.559	122.428	79,73
14	Bangka Belitung	25.918	20.822	80,34
15	Bengkulu	36.814	30.951	84,07
16	Lampung	141.077	108.704	77,05
17	Kalimantan Barat	99.019	82.455	83,27
18	Kalimantan Tengah	47.682	37.155	77,92
19	Kalimantan Selatan	64.976	41.548	63,94
20	Kalimantan Timur	66.768	53.444	80,04
21	Kalimantan Utara	12.368	10.712	86,61
22	Sulawesi Utara	46.198	40.344	87,33
23	Gorontalo	22.524	17.647	78,35
24	Sulawesi Tengah	62.152	44.961	72,34
25	Sulawesi Selatan	169.779	129.532	76,29
26	Sulawesi Barat	28.971	20.980	72,42
27	Sulawesi Tenggara	56.452	43.399	76,88
28	M a l u k u	37.475	31.768	84,77
29	Maluku Utara	25.577	19.360	75,69
30	B a l i	72.781	65.274	89,69
31	Nusa Tenggara Barat	88.445	60.316	68,20
32	Nusa Tenggara Timur	128.286	116.482	90,80
33	Papua	48.828	40.690	83,33
34	Papua Barat	18.179	16.307	89,70
<b>Indonesia</b>		<b>4.400.553</b>	<b>3.436.103</b>	<b>78,08</b>



**Tabel : 35**  
**Angka Melanjutkan SMP ke SM Tiap Provinsi**  
**Tahun 2016/2017**

No.	Provinsi	LULUSAN SMP	SISWA BARU SM	AM %
(1)	(2)	(3)	(4)	(5)
1	DKI Jakarta	125.225	132.539	105,84
2	Jawa Barat	585.506	601.168	102,67
3	Banten	137.437	146.136	106,33
4	Jawa Tengah	410.712	409.295	99,65
5	DI Yogyakarta	44.154	49.577	112,28
6	Jawa Timur	422.254	444.638	105,30
7	Aceh	66.182	67.685	102,27
8	Sumatera Utara	210.676	230.038	109,19
9	Sumatera Barat	68.953	82.251	119,29
10	R i a u	80.164	84.053	104,85
11	Kep. Riau	24.587	23.940	97,37
12	J a m b i	40.649	42.675	104,98
13	Sumatera Selatan	110.855	109.905	99,14
14	Bangka Belitung	17.971	17.875	99,47
15	Bengkulu	28.448	27.021	94,98
16	Lampung	105.271	101.396	96,32
17	Kalimantan Barat	69.917	66.213	94,70
18	Kalimantan Tengah	32.801	31.265	95,32
19	Kalimantan Selatan	39.285	42.531	108,26
20	Kalimantan Timur	48.844	50.629	103,65
21	Kalimantan Utara	9.308	9.057	97,30
22	Sulawesi Utara	37.894	36.494	96,31
23	Gorontalo	15.722	16.720	106,35
24	Sulawesi Tengah	41.346	40.369	97,64
25	Sulawesi Selatan	128.281	125.316	97,69
26	Sulawesi Barat	19.066	18.201	95,46
27	Sulawesi Tenggara	40.012	41.245	103,08
28	M a l u k u	31.213	30.494	97,70
29	Maluku Utara	18.434	17.475	94,80
30	B a l i	66.021	61.838	93,66
31	Nusa Tenggara Barat	58.190	60.905	104,67
32	Nusa Tenggara Timur	98.487	89.949	91,33
33	Papua	33.792	31.054	91,90
34	Papua Barat	13.464	12.607	93,63
<b>Indonesia</b>		<b>3.281.121</b>	<b>3.352.554</b>	<b>102,18</b>



**Tabel : 36**  
**Angka Partisipasi Kasar**  
**PAUD, SD, SMP, SM Sederajat**  
**Tahun 2016/2017**

No.	Jenjang Pendidikan	Kelompok Usia	Penduduk Usia Sek.	Jumlah Siswa	APK (%)
(1)	(2)	(3)	(4)	(5)	(6)
1.	PAUD	3-6 tahun	19.229.800	13.913.680	72,35
2.	TK dan Sederajat	4-6 tahun	14.423.800	5.885.851	40,81
3.	SD dan sederajat	7-12 tahun	27.574.800	29.351.817	106,44
4.	SMP dan sederajat	13-15 tahun	13.425.000	13.566.271	101,05
5.	SM dan sederajat	16-18 tahun	13.276.000	10.879.950	81,95

**Grafik : 12**  
**Angka Partisipasi Kasar**  
**PAUD, SD, SMP, SM Sederajat**  
**Tahun 2016/2017**

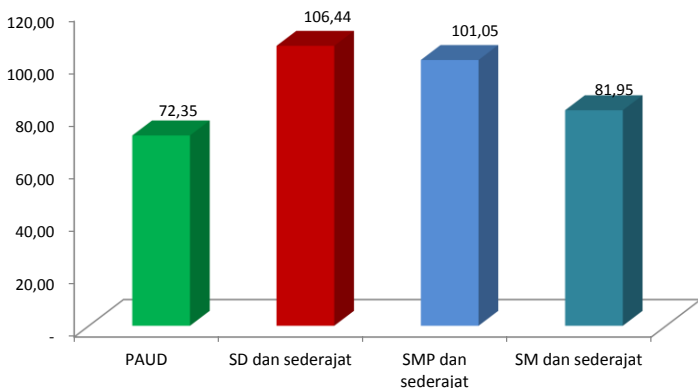



**Tabel : 37**  
**Angka Partisipasi Murni**  
**PAUD, SD, SMP, SM Sederajat**  
**Tahun 2016/2017**

No.	Jenjang Pendidikan	Kelompok Usia	Penduduk Usia Sek.	Jumlah Siswa Usia	APM (%)
(1)	(2)	(3)	(4)	(5)	(6)
1.	TK dan Sederajat	4-6 tahun	14.423.800	5.885.851	40,81
2.	SD dan sederajat	7-12 tahun	27.574.800	25.845.245	93,73
3.	SMP dan sederajat	13-15 tahun	13.425.000	10.241.986	76,29
4.	SM dan sederajat	16-18 tahun	13.276.000	8.124.666	61,20

**Grafik : 13**  
**Angka Partisipasi Murni**  
**PAUD, SD, SMP, SM Sederajat**  
**Tahun 2016/2017**

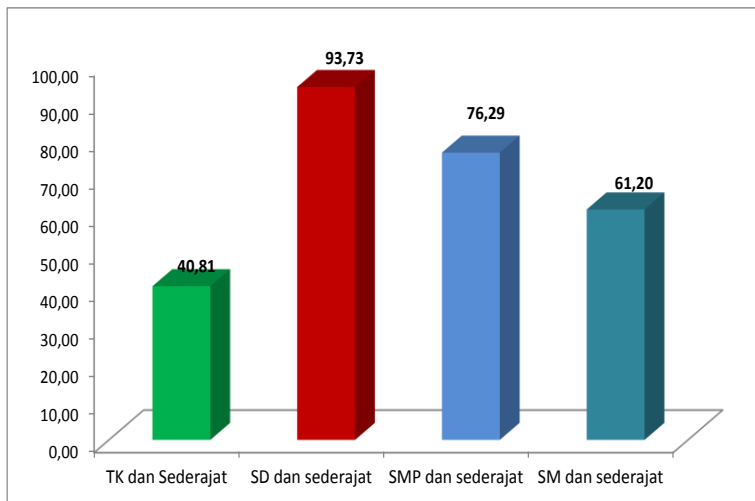



**Tabel : 38**  
**Angka Partisipasi Kasar dan Angka Partisipasi Murni Tiap Provinsi**  
**SD, SMP, SM Sederajat**  
**Tahun 2016/2017**

No.	Provinsi	SD SEDERAJAT		SMP SEDERAJAT		SM SEDERAJAT	
		APK	APM	APK	APM	APK	APM
(1)	(2)	(3)	(4)	(5)	(6)	(7)	(8)
1	DKI Jakarta	103,99	96,15	108,19	84,79	97,25	71,87
2	Jawa Barat	106,17	96,03	99,96	77,87	76,62	57,59
3	Banten	108,28	95,40	99,40	75,12	76,82	57,34
4	Jawa Tengah	104,64	92,16	99,30	75,20	78,04	58,63
5	DI Yogyakarta	98,42	90,58	102,73	80,39	98,80	76,48
6	Jawa Timur	105,06	94,88	103,66	81,11	83,87	65,86
7	Aceh	104,41	91,53	104,06	78,19	86,04	63,27
8	Sumatera Utara	109,56	94,41	104,29	76,81	93,81	67,92
9	Sumatera Barat	108,42	94,84	104,08	78,49	90,07	69,04
10	R i a u	108,71	95,28	95,54	72,87	77,97	58,63
11	Kep. Riau	97,94	87,73	97,79	75,72	93,32	69,39
12	J a m b i	110,26	95,08	99,61	73,54	81,82	59,75
13	Sumatera Selatan	111,61	94,03	98,41	69,77	82,26	58,10
14	Bangka Belitung	109,36	93,95	94,82	68,12	73,13	51,37
15	Bengkulu	111,54	95,84	103,44	76,03	83,35	62,99
16	Lampung	106,28	92,63	99,95	74,68	77,81	59,18
17	Kalimantan Barat	113,01	93,86	102,71	73,45	74,99	53,81
18	Kalimantan Tengah	111,01	96,12	99,45	73,26	73,33	53,51
19	Kalimantan Selatan	106,42	93,05	97,10	72,19	74,51	55,72
20	Kalimantan Timur	107,84	95,10	100,56	75,08	85,87	62,38
21	Kalimantan Utara	106,10	92,99	93,35	69,91	79,31	58,70
22	Sulawesi Utara	106,16	89,93	106,93	72,19	91,95	60,65
23	Gorontalo	111,13	95,82	99,36	75,56	81,31	61,48
24	Sulawesi Tengah	108,99	94,63	108,15	81,61	81,98	61,24
25	Sulawesi Selatan	105,83	92,41	102,78	75,78	84,99	61,43
26	Sulawesi Barat	104,62	91,13	104,98	78,57	79,83	59,23
27	Sulawesi Tenggara	105,20	89,63	108,74	77,54	92,96	66,50
28	M a l u k u	102,36	86,95	106,82	73,43	94,64	64,57
29	Maluku Utara	109,36	93,38	108,78	76,99	91,43	64,66
30	B a l i	105,33	94,93	104,38	80,96	96,52	73,50
31	Nusa Tenggara Barat	106,28	93,14	105,89	79,88	90,85	69,98
32	Nusa Tenggara Timur	112,82	93,66	100,17	69,67	78,62	56,91
33	Papua	88,75	72,30	64,93	42,86	49,31	33,24
34	Papua Barat	115,04	93,86	98,95	64,93	83,37	56,68
<b>Indonesia</b>		<b>106,44</b>	<b>93,73</b>	<b>101,05</b>	<b>76,29</b>	<b>81,95</b>	<b>61,20</b>